A decorative graphic consisting of several overlapping, wavy, blue lines that create a sense of motion and depth, positioned horizontally across the middle of the page.

**Mirage S+/HD/WU,
Matrix S+/HD/WU,
Christie HD/DS+/DW, DLV**

USER MANUAL

020-100001-07

CHRISTIE®

**Mirage S+/HD/WU,
Matrix S+/HD/WU,
Christie HD/DS+/DW, DLV**

USER MANUAL

020-100001-07

NOTICE

This equipment has been tested and found to comply with the limits for a Class A digital device, pursuant to Part 15 of the FCC Rules. These limits are designed to provide reasonable protection against harmful interference when the equipment is operated in a commercial environment. This equipment generates, uses, and can radiate radio frequency energy and, if not installed and used in accordance with the instruction manual, may cause harmful interference to radio communications. Operation of this equipment in a residential area is likely to cause harmful interference in which case the user will be required to correct the interference at his own expense.

This Class A digital apparatus complies with Canadian ICES-003.

Cet appareil numérique de la classe A est conforme à la norme NMB-003 du Canada.

The equipment is designed and manufactured with high-quality materials and components that can be recycled and reused. This symbol  means that electrical and electronic equipment, at their end-of-life, should be disposed of separately from regular waste. Please dispose of this equipment appropriately and according to local regulations. In the European Union, there are separate collection systems for used electrical and electronic products. Please help us to conserve the environment we live in!

Copyright 2005-2009 Christie Digital Systems USA, Inc. All rights reserved. All brand names and products are trademarks, registered trademarks or trade names of their respective holders. Canadian manufacturing facility is ISO 9001 and 14001 certified. Performance specifications are typical, but may vary depending on conditions beyond Christie's control such as maintenance of the product in proper working conditions. Performance specifications are available at the time of printing. Every effort has been made to ensure accuracy, however in some cases changes in the products or availability could occur which may not be reflected in this document. Christie reserves the right to make changes without notice or obligation.

WARRANTY

For complete information about Christie's limited warranty, please contact your Christie Dealer. In addition to the other limitations that may be specified in Christie's limited warranty, the warranty does not cover:

- a. Damage occurring during shipment, in either direction.
- b. Projector lamps (See Christie's separate lamp program policy).
- c. Damage caused by use of a projector lamp beyond the recommended lamp life, or use of a lamp supplied by a supplier other than Christie.
- d. Problems caused by combination of the equipment with non-Christie equipment, such as distribution systems, cameras, video tape recorders, etc., or use of the equipment with any non-Christie interface device.
- e. Damage caused by misuse, improper power source, accident, fire, flood, lightening, earthquake or other natural disaster.
- f. Damage caused by improper installation/alignment, or by equipment modification, if by other than Christie service personnel.
- g. For LCD projectors, the warranty period specified applies only where the LCD projector is in "normal use." "Normal use" means the LCD projector is not used more than 8 hours a day, 5 days a week. For any LCD projector where "normal use" is exceeded, warranty coverage under this warranty terminates after 6000 hours of operation.
- h. Failure due to normal wear and tear.

PREVENTATIVE MAINTENANCE

Preventative maintenance is an important part of the continued and proper operation of your projector. Please see the Maintenance section for specific maintenance items as they relate to your projector and/or model. Failure to perform maintenance as required and in accordance with the maintenance schedule specified by Christie will void the warranty.

Table of Contents

1 INTRODUCTION	1.1 Projector Overview	1-1
	1.2 Components.....	1-3
	1.3 Purchase Record and Servicing.....	1-4
2 INSTALLATION & SETUP	2.1 Quick Setup.....	2-1
	2.2 Installation Considerations.....	2-3
	2.3 Connecting Sources.....	2-12
	2.4 Connecting Communications	2-15
	2.5 System Integration – GPIO Connector.....	2-19
	2.6 Power Connection	2-20
3 OPERATION	3.1 About the Projector	3-1
	3.2 Using the Remote or Built-in Keypad.....	3-3
	3.3 Navigating the Menus	3-10
	3.4 Using Inputs and Channels.....	3-14
	3.5 Adjusting the Image	3-19
	3.6 Adjusting System Parameters and Advanced Controls.....	3-39
	3.7 Working with PIP and Seamless Switching.....	3-53
	3.8 Working with the Lamp	3-56
	3.9 Status Menu	3-60
	3.10 Using Multiple Projectors	3-60
	3.11 Remote Control of the Projector	3-72
	3.12 Error Conditions.....	3-73
4 MAINTENANCE	4.1 Warnings and Safety Guidelines	4-1
	4.2 Cleaning and Maintenance Guide	4-4
	4.3 Replacing Remote Batteries	4-5
	4.4 Lamp and Filter Replacement	4-5
	4.5 Replacing the Projection Lens.....	4-11
5 TROUBLESHOOTING	5.1 Displays.....	5-1
	5.2 Lamp	5-3
	5.3 Ethernet.....	5-3
	5.4 3D Sync Input	5-4
6 SPECIFICATIONS	6.1 Specifications	6-1
APPENDICES	Appendix A: Keypad Reference.....	A-1
	Appendix B: Serial Communications Cables	B-1
	Appendix C: System Integration	C-1
	Appendix D: Optional Input Modules	D-1
	Appendix E: Menu Tree	E-1

NOTE: *Due to continuing research, all information in this manual is subject to change without notice.*

Introduction

1.1 Projector Overview

The Mirage S+/HD/WU, Matrix S+/HD/WU, Christie HD/DS/DW, DLV User Manual supports software v1.7d or higher. The projectors listed below are all professional 3-chip projectors, based on next-generation Digital Light Processing™ (DLP™) technology by Texas Instruments™ to deliver high quality, crisp, clean images.

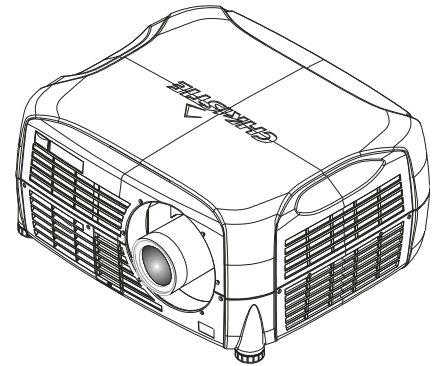

Mirage S+3K/6K and *Mirage HD3/6* and *Mirage WU3/7* projectors provide a powerful combination of HD, SXGA+ and WUXGA resolutions, high brightness and high contrast ratios to produce flawless, realistic three-dimensional graphic images for simulation, virtual reality and other stereographic related applications.

Additional reliable and compact projectors are the *Matrix S+2K/5K/HD2/HD4/HD7/WU2/WU5* *Matrix 4000*. With their purpose built simulation features such as RGB color matching, and gamma controls, it can be used to simulate any application.

The *DLV1400-DX* and *DLV1920-DX* are designed for the demands of 24/7 control room applications and provide long-term reliability and performance.

This guide applies to the following projector models:

Mirage S+3K	Matrix HD7	Christie HD6K
Mirage S+6K	Matrix 4000	Christie HD8K
Mirage HD3	Matrix WU2	Christie HD2Kc
Mirage HD6	Matrix WU5	Christie HD5Kc
Mirage WU3	DLV1400-DX	Christie HD7Kc
Mirage WU7	DLV1920-DX	Christie DW5K
Matrix S+2K	Christie DS+6K	Christie DW8K
Matrix S+5K	Christie DS+8K	Christie DW6Kc
Matrix HD2	Christie DS+5Kc	Christie DW4Kc
Matrix HD4	Christie HD3K	

- Main Features**
- Native SXGA+, HD, HD2 or WUXGA resolution (*model dependant*) with all others fully scalable
 - Internal scaling of stereo signals (*Mirage models*)
 - 10-bit video processing
 - Built-in multi-standard video decoder
 - Display of NTSC, PAL and SECAM video input
 - User replaceable Cermax® Xenon lamp
 - LiteLOC™ for constant brightness
 - Intelligent Lens System (ILS™) to save and restore lens settings
 - Motorized lens mount for all models
 - Auto-setup feature
 - Integrated ChristieNET™
 - Networking ability through RS232 and RS422 connectors
 - Status LED display on built-in keypad for easy projector status monitoring
 - Control with IR, wired or built-in keypad
 - Two input slots for Optional Input Modules

Refer to **Section 6** for a complete list of Specifications including Brightness and Contrast and Optional Input Modules

Inputs There are two different types of input face plate configurations (model dependant). See Figure 1.1 & 1.2. These configurations may include the following inputs:

- One analog RGBHV/YPbPr input with five BNCs
- One DVI-I input for either digital RGB/YCrCb or analog RGB/YPbPr signals
- One analog composite-video input
- One analog S-video input
- Built-in multi-standard video decoder (*NTSC, NTSC 4.43, PAL, PAL-M, PAL-N, PAL-60 AND SECAM*)
- One Dual SD/HD-SDI module (standard on *all Christie HD* models only and is optional for *Mirage* (or *Matrix*) models.)
- Compatible with all currently used HDTV formats

For simplicity, this manual refers to the configuration in Figure 1.1 only.

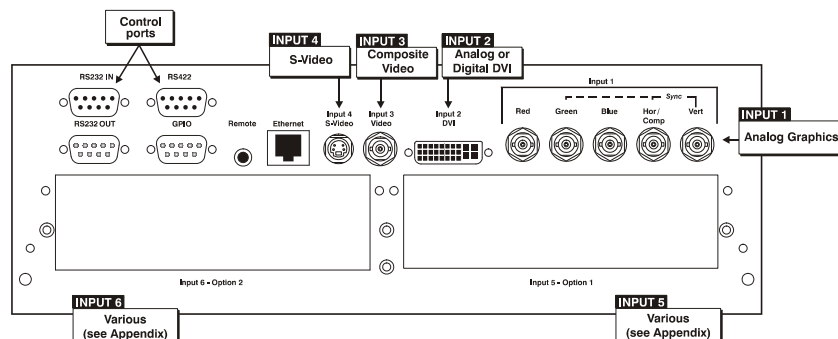

Figure 1.1

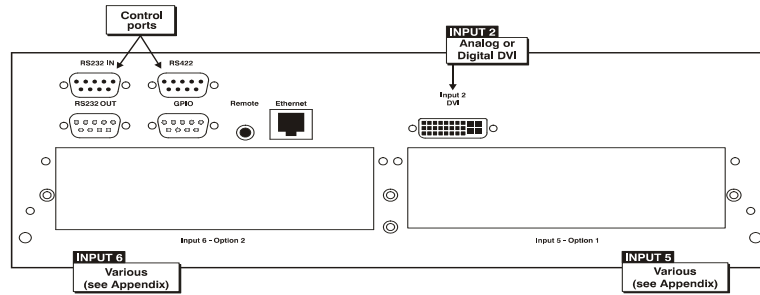

Figure 1.2

How the projector works ► The projector accepts data/graphics and video input signals for projection onto front or rear flat screens. High brightness light is generated by an internal Xenon lamp then modulated by three Digital Micro-mirror Device (DMD) panels that provide digitized red, green or blue color information. Light from the “on” pixels of each panel is reflected, converged and then projected to the screen through a single front lens, where all pixels are perfectly superimposed as a sharp full-color image (2D or 3D for *Mirage models only*).

1.2 Components

The following listed items are shipped with your projector. Ensure you have received all these items before using your projector.

- IR remote keypad (*includes two, 1.5V AA batteries and a mini-stereo cable for conversion to wired*)
- Line cord
- Stereo 3D Cable (*Mirage only*)
- Warranty Card

Lamp Type	Model Name	Resolution	Christie TWIST	3D	Motorized Lens Mount
500W Models	DLV1400-DX	SXGA+	Optional	•	✓
	DLV1920-DX	HD	Optional	•	✓
	Christie HD3K	HD	Optional	•	✓
	Christie HD2Kc	HD	Optional	•	✓
	Mirage S+3K	SXGA+	Optional	✓	✓
	Mirage HD3	HD	Optional	✓	✓
	Mirage WU3	WUXGA	Optional	✓	✓
	Matrix S+2K	SXGA+	✓	•	✓
	Matrix HD2	HD	✓	•	✓
	Matrix WU2	WUXGA	✓	•	✓
1000W Models	DW5K, 4Kc	HD2	Optional	•	✓
	Christie DS+6K/5Kc	SXGA+	Optional	•	✓
	Christie HD6K/5Kc	HD	Optional	•	✓
	Mirage S+6K	SXGA+	Optional	✓	✓
	Mirage HD6	HD	Optional	✓	✓
	Mirage WU7	WUXGA	Optional	✓	✓
	Matrix S+5K	SXGA+	✓	•	✓
	Matrix HD4	HD	✓	•	✓
	Matrix WU5	WUXGA	✓	•	✓
	Matrix 4000	HD	✓	•	✓
1200W Models	DW8K, DW6Kc	HD2	Optional	•	✓
	Christie DS+8K	SXGA+	Optional	•	✓
	Christie HD8K/7Kc	HD	Optional	•	✓
	Matrix HD7	HD	✓	•	✓

NOTE: Kc models include the same features, but are color corrected to film color standards.

1.3 Purchase Record and Warranty Registration

Whether the projector is under warranty or the warranty has expired, Christie's highly trained and extensive factory and dealer service network is always available to quickly diagnose and correct projector malfunctions. Service manuals and updates are available to service technicians for all projectors.

If you encounter any problems with the projector and require assistance, contact your dealer or Christie Digital Systems. Fill out the information in the table below and keep with your records for future reference.

Purchase Record

Dealer:
Dealer Phone Number:
Projector Serial Number:
Purchase Date:
Installation Date, if applicable:

NOTE: *The serial number can be found on the license label, which is located at the back of the projector.*

You can also register your product on-line by visiting www.christiedigital.com ⇒ **Service and Support ⇒ Product Registration**. This will keep you in touch with all the latest product information, such as updates, technical bulletins, downloads and Christie newsletters.

For complete details on the warranty of your Christie product, please contact your Christie dealer.

Installation & Setup

2.1 Quick Setup

The instructions provided here are for those that are familiar with the projector and wish to quickly set it up and use it temporarily. Refer to the remaining subsections of this manual for a more complete setup.

Step 1 ► **Install a Projection Lens**

The projection lens is shipped separately from the projector and must be installed prior to setting up the projector. Install the projection lens as described in **4.5 Replacing the Projection Lens**.

 **Remove the lens plug** from the lens opening in the projector before installing the lens.

 **Remove the lens when shipping** the projector and **reuse the lens plug** to prevent dust and debris from entering and settling on the projector's optical components.

Step 2 ► **Position the Projector**

Place the projector on a sturdy, level surface and position it so that it is perpendicular to the screen at a suitable distance. In general, the further back the projector is positioned from the screen, the larger the image will be.

If required, you can level the projector by adjusting its three feet. With the projector positioned perpendicular to the screen the image will appear rectangular instead of keystone.

For more detailed instructions on positioning the projector refer to **Projector Position and Mounting** later in this section.

Step 3 ► **Connect a Source**

Located at the back of the projector is the input panel where all source connections are made. Each input is clearly labeled for easy identification.

Using the appropriate cable(s), connect your source. Connect RGB and YPbPr sources to **INPUT 1** located in the upper right corner of the input panel. Use the DVI-I connector at **INPUT 2** to connect analog or digital display signals. Connect composite video to **INPUT 3** and S-video to **INPUT 4**.

NOTE: *One of the available optional input modules can be installed at **INPUT 5** or **INPUT 6** for additional connections.*

*Refer to **2.3 Connecting Sources** for more details on connecting a specific source.*

Step 4 ▶ Connect the Line Cord

 **The North American-rated line cord is provided with each projector. Ensure that you are using a line cord, socket and power plug that meets the appropriate local rating standards.**

Plug the line cord to the AC receptacle located on the right hand side of the projector and the three-pronged end into a grounded AC outlet. Ensure the socket outlet is installed near the equipment and is easily accessible. The input voltage to the projector must be capable of 100 – 240 VAC in *500W* and *1000W* models and 200-240 VAC in *1200W* models. (See **Section 6 – Specifications** for complete details on all power requirements.)

Use the approved North American-rated line cord supplied with the projector. If you are connecting to an area outside of North America ensure an appropriately rated line cord is used.

Step 5 ▶ Turn the Projector ON

Press the  POWER button on either the remote or built-in keypad to turn the projector on. Wait a few minutes to allow the projector to warm up. The LED status window displays an active pattern of segments to indicate the projector is changing its state from powered down to powered up. The message “On” appears in the display when the projector has completed its initialization and is ready for use.

Step 6 ▶ Select a Source

Press one of the input keys on the remote or built-in keypad to select and display the image for the source you connected in Step 3.

Step 7 ▶ Adjust Image

Adjust the more common image settings, such as Brightness, Contrast, Gamma, Focus, Zoom etc. using the direct keys on the IR remote.

You can also access the menu system and adjust these and other image settings by pressing  on the remote.

2.2 Installation Considerations

Proper installation of your projector will ensure the quality of your display. Whether you are installing a projector temporarily or permanently you should take the following into account to ensure your projector performs optimally.

Installation type ► Choose the installation type that best suits your needs: front or rear screen, floor mount or inverted mount.

Front Screen, Floor Mount Installation

ADVANTAGES	CONSIDERATIONS
<ul style="list-style-type: none"> • Easy to set up • Can be moved or changed quickly • Easy to access 	<ul style="list-style-type: none"> • Shares floor space with audience

Front Screen, Inverted Mount (ceiling) Installation

ADVANTAGES	CONSIDERATIONS
<ul style="list-style-type: none"> • Does not take up audience space • Projector is unobtrusive • Projector cannot be accidentally moved 	<ul style="list-style-type: none"> • Installation is more permanent • It is more difficult to access the projector

Rear Screen, Floor Mount Installation

ADVANTAGES	CONSIDERATIONS
<ul style="list-style-type: none"> • Projector is completely hidden • Projector is easily accessed • Usually good ambient light rejection 	<ul style="list-style-type: none"> • Requires separate room • Installation cost is usually higher

Rear Screen, Inverted Mount (ceiling) Installation

ADVANTAGES	CONSIDERATIONS
<ul style="list-style-type: none"> • Projector is completely hidden • Usually good ambient light rejection 	<ul style="list-style-type: none"> • Requires separate room • Installation cost is usually higher

Rear Screen, Floor Mount with Mirror

ADVANTAGES	CONSIDERATIONS
<ul style="list-style-type: none"> • Projector is completely hidden • Usually good ambient light rejection • Requires less space behind screen than other rear screen installations 	<ul style="list-style-type: none"> • Requires separate room • Installation cost is usually higher

Screen Type ► **Front Screen Installations**

In front screen installations the projector and audience are positioned in front of the screen, which can be flat or curved.

Flat screens are most recommended with this projector. They offer a gain of about one with a viewing angle just less than 180°. This type of screen reflects incident light equally in all directions so the audience can see the display from various angles.

Curved screens have a gain greater than one with a viewing angle much less than 180°. This type of screen does not reflect incident light equally in all directions instead it is concentrated in a viewing cone. The audience sitting within the viewing cone area will see a brighter image than those sitting just outside this area.

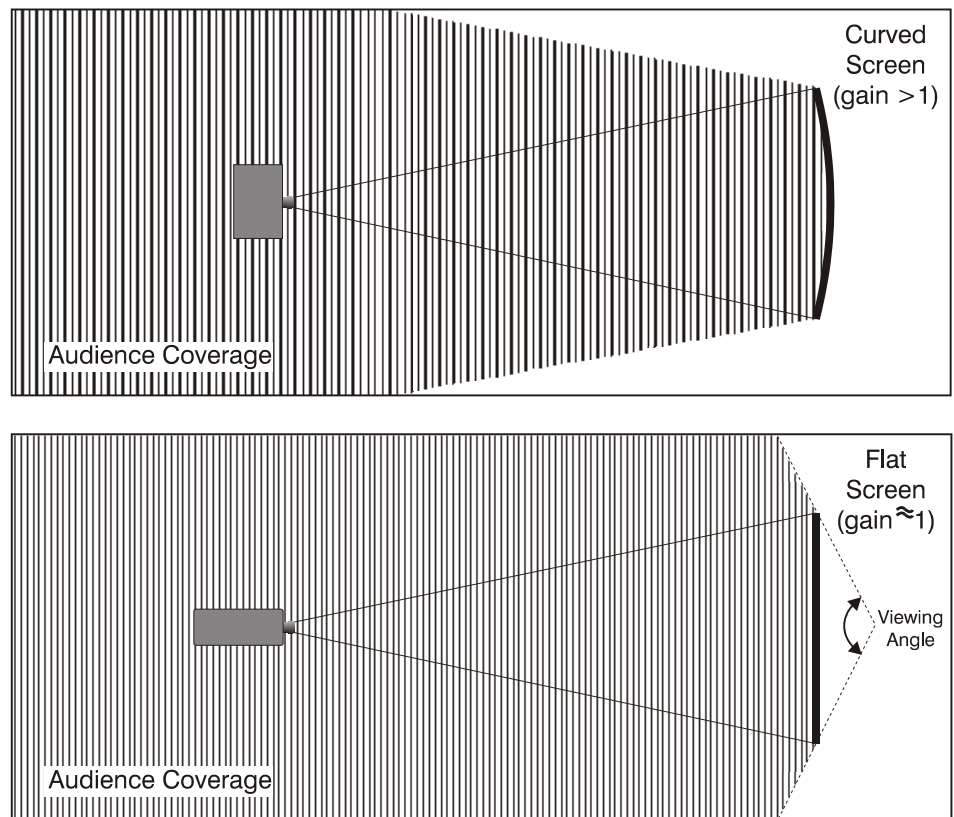

Rear screen installations

There are two basic types of rear screens: diffused and optical.

A diffused screen has a surface, which spreads the light striking it. Purely diffused screens have a gain of less than one. The main advantage of the diffused screen is its wide viewing angle, similar to that of a flat screen for front screen projection. This type of screen is suitable when a wide viewing angle is required but there is low ambient room lighting.

Optical screens take light from the projector and redirect it to increase the light intensity at the front of the screen. This reduces it in other areas. A viewing cone, similar to that of a curved front screen installation is created. This type of screen is better suited for brightly lit rooms where the audience is situated within the viewing cone.

Screen size

Choose a screen size, which is appropriate for your lens and application. Keep in mind that if the projector will be used to display text information, the image size must allow the audience to recognize all text clearly. The eye usually sees a letter clearly if eye-to-text distance is less than 150 times the height of the letter. Small text located too far from the eye will likely be illegible at a distance no matter how sharply and clearly it is displayed.

To fill a screen with an image, the aspect ratio of the screen should be equal to the aspect ratio of the image (expressed as the ratio of its width to its height). Standard video from a VCR has a 4:3 or 1.33:1 aspect ratio. For example, to display a VCR output with a 4:3 aspect ratio onto a 10-foot (3m) high screen, the width of the screen must be at least 13.3 feet (4m).

Ambient Lighting ► The high brightness of this projector is well suited for locations where ambient lighting might be considered less than ideal for projection. A typical room with ceiling lights and windows rarely requires special attention. Contrast ratio in your images will be noticeably reduced only if light directly strikes the screen, such as when a shaft of light from a window or floodlight falls on the image. Images may then appear washed out and less vibrant.

In general, avoid or eliminate light sources directed at the screen.

Other Considerations ► Other considerations and tips that can help improve your installation:

- Keep the ambient temperature constant and below 35°C (95°F). Keep the projector away from heating and/or air conditioning vents. Changes in temperature may cause drifts in the projector circuitry, which may affect performance.
- Keep the projector away from devices, which radiate electromagnetic energy such as motors and transformers. Common sources of these include slide projectors, speakers, power amplifiers, elevators, etc.

Choose the best screen size for the application. Since more magnification reduces brightness, use a screen size appropriate for the venue but not larger than required. Installing a large screen in a small room is similar to watching television at a close range; too large a screen can overpower a room and interfere with the overall effect. A good rule of thumb is to be no closer than 1.5 times the width of the screen.

Projector Position and Mounting

► **Throw distance**

Throw distance is the distance measured from your projector’s front feet to the screen. This is an important calculation in any projector installation as it determines whether or not you have enough room to install your projector with a desired screen size and if your image will be of the right size for your screen.

You can quickly estimate the throw distance by taking the horizontal width of the screen and multiplying it by the lens throw ratio. The result of this calculation tells you roughly how far back the projector should be positioned from the screen in order to project a focused image large enough to fill the screen. For example, using a 0.73:1 lens, throw distance would roughly be 0.73 x screen width.

IMPORTANT! *Use the lens and screen size to calculate the precise throw distance using the tables provided in the Dealer Section of the Christie Website, PN 020-100298-xx. Due to lens manufacturing tolerances for lens focal length, actual throw distance and vary ±5% between lenses with the same nominal throw ratio.*

Throw Distance (TD) = Screen Width (w) X Lens Throw Ratio

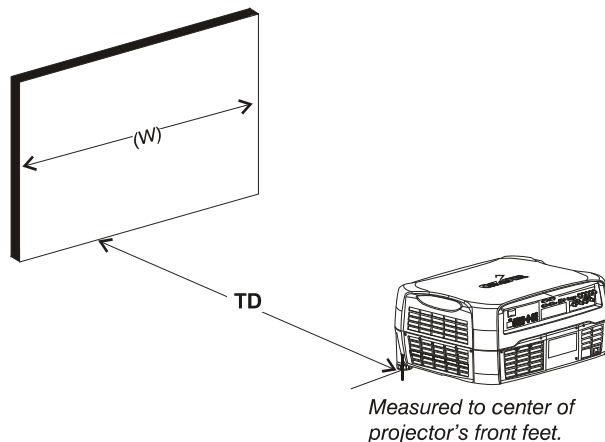

Vertical and horizontal position

The correct vertical and horizontal position of the projector in relation to the screen depends on the lens type and the screen size. Ideally, the projector should be positioned perpendicular to the screen. This way, the image will appear rectangular instead of keystone (trapezoidal).

The **vertical position** of the image can be offset – that is moved above or below the optical axis (lens center) by adjusting the fully motorized lens mount with the keypad. The amount of vertical offset available depends directly on the lens installed in the projector and can be slightly limited if horizontal offset has been applied. Vertical offset can also be expressed as the percent of half the image height OR the number of pixels of shift from lens center. Refer to Figure 2.1 for some illustrated examples of vertical offset.

Table 2.1 along with Figure 2.2 show the maximum vertical offset of a lens or alternatively, how much of your projected image will appear above or below lens center if the maximum vertical offset is applied using that lens.

Table 2.1. Lens Offsets

Lens Type (All motorized lenses)	Offset Movement		Max. Amount of Display Above or Below Lens Center	Max. Amount of Display Right or Left of Lens Center		
	↑ or ↓	← or →				
SXGA+ Lenses	100%	50%	1050 pixels ↑ or ↓	100%	1050 pixels ← or →	75%
HD Lenses	119%	42%	1183 pixels ↑ or ↓	100%	1363 pixels ← or →	71%
WU Lenses	112%	54%	1243 pixels ↑ or ↓	100%	1478 pixels ← or →	77%

NOTES: 1) Offsets are subject to ±7% centering tolerance **2)** % Offset = # pixels of offset / half panel resolution x 100. **3)** 0.73:Fixed and 1.16-1.49 Zoom Lenses have less offset. See Specification section, Lenses for more details.

Examples of Vertical Offset (SXGA+ pixels represented)

Where:

Shaded area = projected image

Area within solid line = projected image area with no offset applied

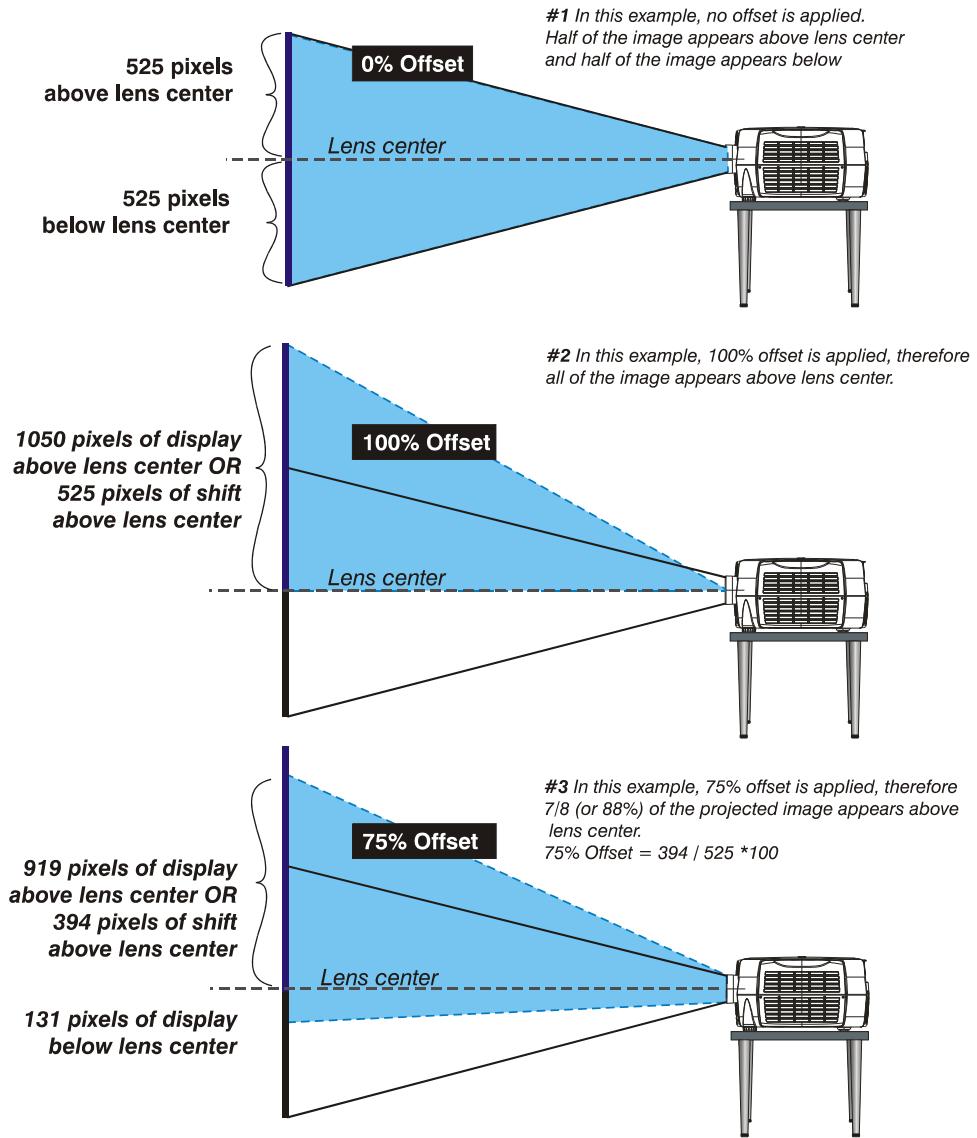
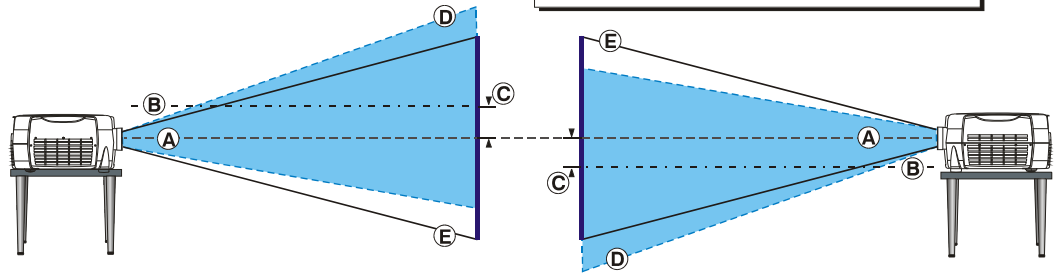

Figure 2.1. Vertical Offset Examples

Vertical Offset for Fixed Lenses

Where:
 (A) = Lens center (optical axis)
 (B) = Projected image vertical center
 (C) = Vertical offset (maximum)
 (D) = Projected image area with full offset applied (shaded area)
 (E) = Projected image area with no offset applied (area within solid lines)



Vertical Offset for Zoom Lenses

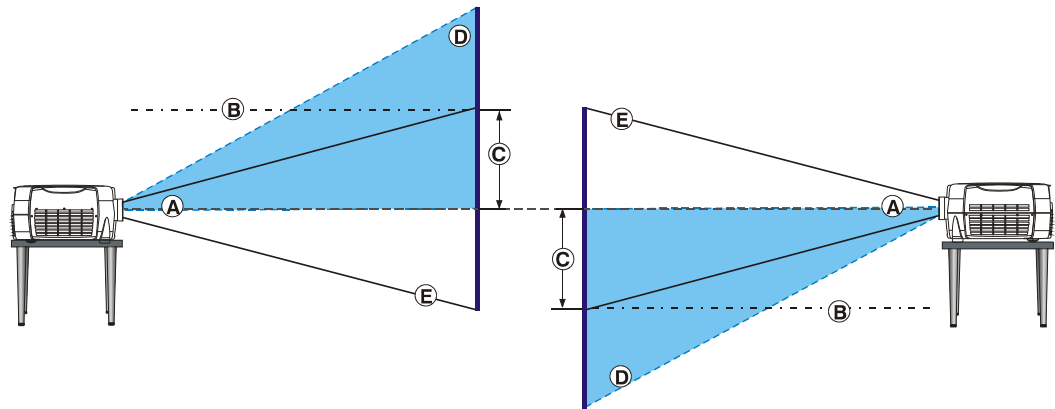

Figure 2.2. Lens Vertical Offsets

The **horizontal position** of the image can be offset – that is moved to the left or right of lens center, by adjusting the fully motorized lens mount through software. The amount of horizontal offset available depends on the lens installed and if the image has already been vertically offset. Horizontal offset can also be expressed as the percent of half the image width – the number of pixels of shift to one side of lens center. Refer to Figure 2.3 for some illustrated examples of horizontal offset.

See also Table 2.1 along with Figure 2.4 which shows the maximum horizontal offset of a lens or alternatively, how much of your projected image will appear to one side of lens center if the maximum horizontal offset is applied using that lens.

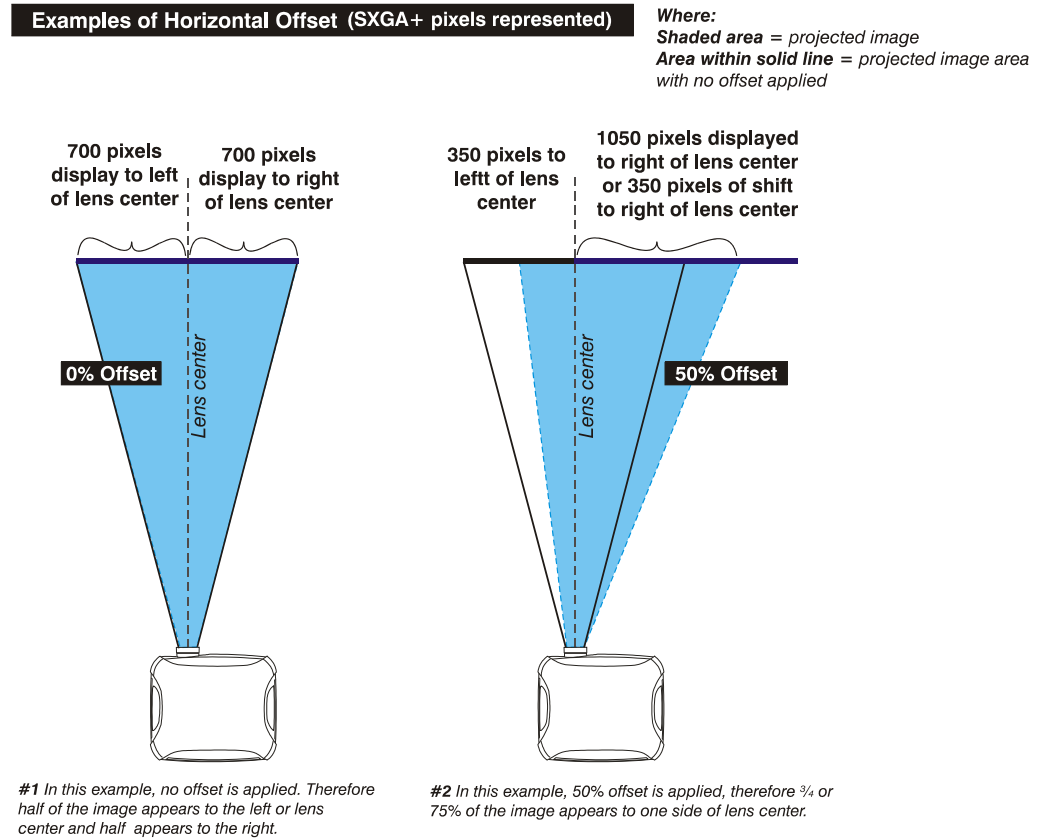
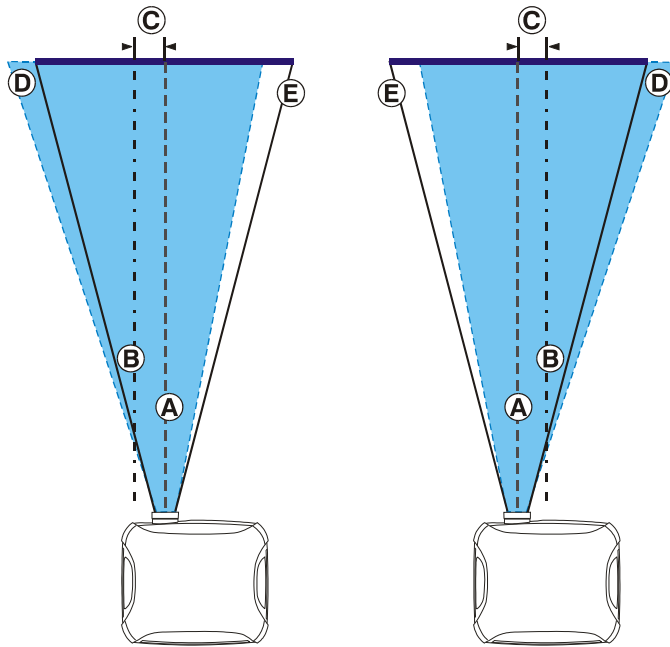

Figure 2.3. Horizontal Offset Examples

Horizontal Offset for Fixed Lenses



Horizontal Offset for Zoom Lenses

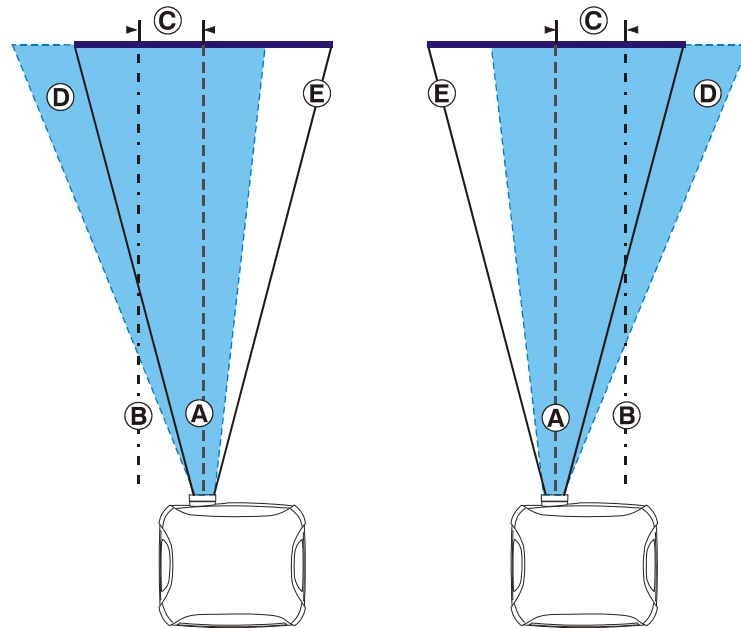

Figure 2.4. Lens Horizontal Offsets

Mounting

There are several methods for mounting the projector. Depending on your chosen installation, one method may be more suitable than another. In typical front and rear screen installations the projector can be mounted to a secure and level surface, such as a table or cart. Carts are useful when the projector has to be moved during a presentation or from site to site. It is recommended you lock the wheels on a cart, when it's in position, to prevent someone from accidentally moving it during a presentation.

CEILING MOUNT - The projector can also be inverted and suspended from the ceiling using a specially designed ceiling mount fixture. This type of mounting is recommended for fixed installations and for those that want the projector out of plain view or have a limited amount of space for projector and audience. For more information, contact your dealer.

⚠ Use only the CHRISTIE approved ceiling mount kit designed for your projector. Refer to the installation instructions and safety guidelines provided in the kit.

SPECIAL MOUNTING – The projector can be rotated (front-to-back) up to 360 degrees and mounted without it affecting performance. However, the side-to-side tilt limit of the projector must not exceed ± 15 degrees. This tilt limit is required to ensure optimal performance of the projector.

STACKING – An optional stacking frame is available for all models which allows stacking up to a maximum of three projectors in an upright or inverted orientation. Refer to the instructions provided in the Stacking Frame kit (104-117101-xx) for details regarding the assembly.

Adjusting projector height

You can modify the height of the projector to remedy a slightly uneven mounting surface by adjusting the two feet threaded into the bottom chassis. Turn each foot clock-wise or counter-clockwise until the project is level on all sides.

Folded Optics

In rear screen applications where space behind the projector is limited, a mirror may be used to fold the optical path. See Figure 2.5. The position of the projector and mirror must be accurately set – if considering this type of installation call your dealer for assistance.

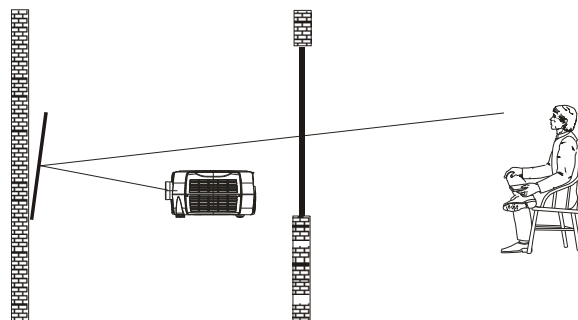

Figure 2.5. Folded Optical Path

2.3 Connecting Sources

Sources connect to the *Input Panel* located at the back of the projector. See Figure 2.6.

The upper right corner (**INPUT 1**) typically accepts an *RGB signal* from an external analog RGB source, or it can also be used for YPbPr signals or additional video sources. Just beside these BNCs, the DVI-I connector (**INPUT 2**) accepts digital or analog display signals from a computer. Connect analog *composite video* at **INPUT 3** or *S-video* at **INPUT 4** from devices such as VCRs, laser disc players or DVD players.

There are also several optional interfaces available for connecting other sources—these interfaces slide into the remaining unused option slot, and can be done while the projector is running.

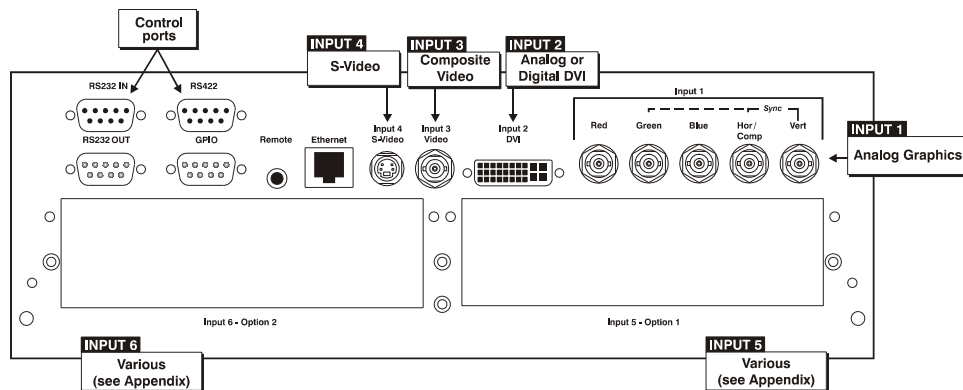

Figure 2.6. Input Panel

- NOTES:** 1) See *Section 6 – Specifications* for details regarding compatible inputs.
 2) Use high quality shielded cables only for all connections.

RGB Signals ► **INPUT 1** consists of five BNCs (connectors) for linking to a variety of sources. The typical connection would be to an RGB source such as a PC, Mac, DEC, Sun, SGI and others. This projector supports multiple sync types with RGB signals: sync-on-green, composite sync, and separate H & V syncs.

NOTE: Depending on your source, you may need a custom adapter cable with BNC connectors at the projector end and a different type of connector at the other (such as a 15-pin "D" connector for some computer sources). Contact your dealer for details.

Connect the **SYNC** BNC input(s) first. Then connect the red, green and blue source outputs to the **RED**, **GREEN**, and **BLUE** BNCs on the **INPUT 1** panel. If the source uses sync-on-green, only the red, green, and blue connections are required. If the source provides a composite sync output, connect it to the **SYNC** input labeled **HOR/COMP**. If the source provides separate horizontal and vertical sync outputs, connect horizontal sync to the **SYNC** input labeled **HOR/COMP** and connect vertical sync to **SYNC** input labeled **VERT**. See Figure 2.7.

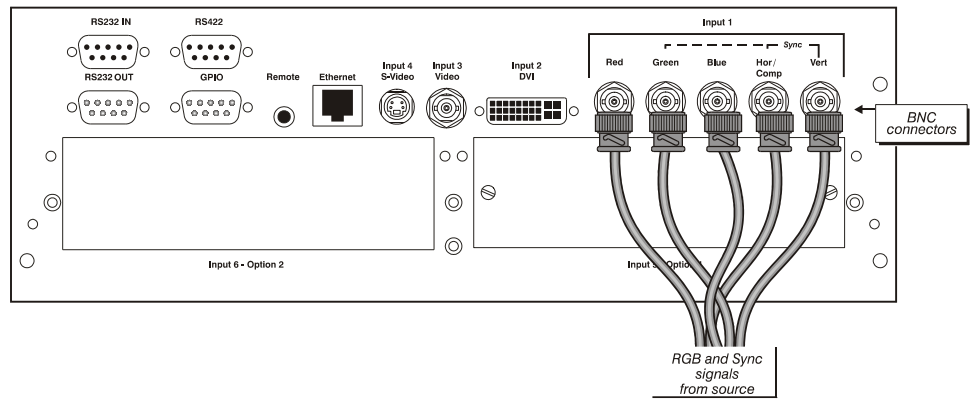

Figure 2.7. Connecting RGB and Sync

NOTES: 1) If for some reason the projector fails to recognize a signal as an RGB signal, specify this **Color Space** option within the **Image Settings** menu. See 3.5 **Adjusting the Image.** **2)** To connect YPbPr signals—such as from DVDs or analog HDTV sources—to **INPUT 1**, use the red, green and blue BNCs as described in **YPbPr Signals** (below).

YPbPr Signals (COMPONENT VIDEO)

▶ Connect an YPbPr signal (*component video*) to **INPUT 1** or **INPUT 2** as shown in Figure 2.8.

NOTES: 1) If, for some reason, the projector fails to recognize an YPbPr signal, specify this **Color Space** option within the **Image Settings** menu. See 3.5, **Adjusting the Image.** **2)** Do not connect digital component signals (known as YCbCr) to **INPUT 1**. Install an appropriate optional module in **INPUT 5** or **INPUT 6** for this.

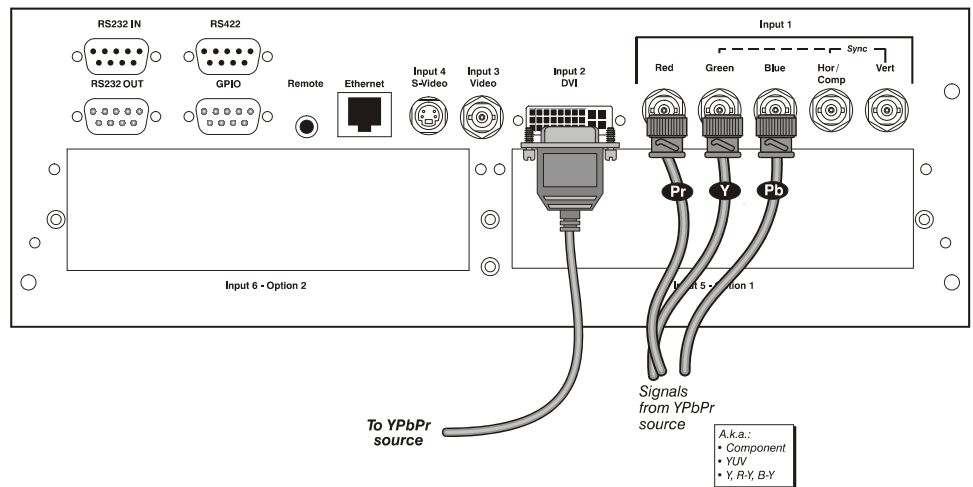

Figure 2.8. Connecting YPbPr sources

Composite and S-Video ► **INPUT 3** and **INPUT 4** provide simultaneous connection of both a composite video source (**INPUT 3**) and an S-Video source (**INPUT 4**). See Figure 2.9.

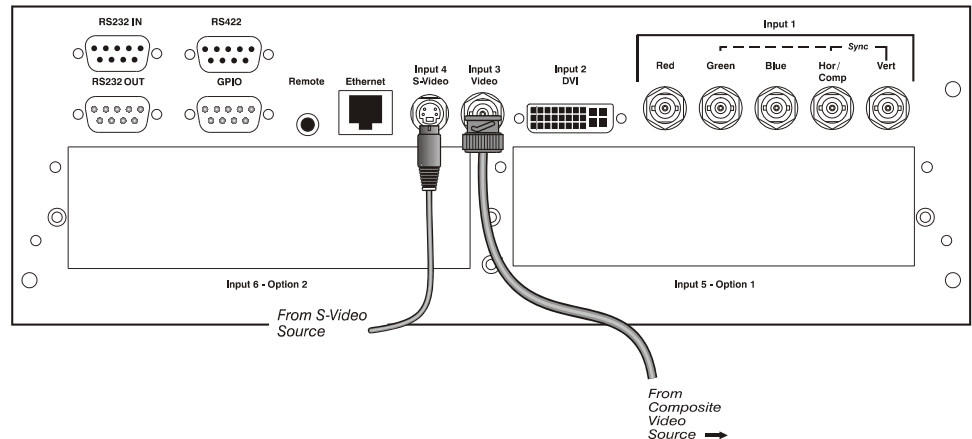

Figure 2.9. Connecting Composite or S-Video sources

DVI Digital Video ► Use the DVI-I connector at **INPUT 2** to connect either analog or digital video devices to the projector. When connecting devices that transmit an analog video signal such as VCRs, laptops, and PCs use the DVI cable provided with the projector. Plug the DVI-I (single link) connector end to the projector and the 15-pin VGA connector to the device.

Use a cable with DVI-I connectors at both ends to connect devices that transmit digital and analog video signals such as high-quality DVD players, satellite receiver and digital cable TVs.

NOTES: 1) To ensure true digital output from devices that transmit digital signals, connect to the DVI-I connector. **2)** DVI loop through is not available unless you have the optional **DVI Input Module** installed at **INPUT 5** or **INPUT 6**.

Optional Inputs ► Optional modules allow you to increase your total number of inputs and/or accommodate different signal types, whether analog or digital. Install in the areas labeled **INPUT 5** or **INPUT 6**. Options include:

- RGB 500 Input Module
- RGB 400 Active Loop Thru Input Module
- RGB 400 Buffered Amplifier Input Module
- PC250 Analog Input Module
- Serial Digital Input Module
- DVI Input Module (*optional*)
- Dual SD/HD-SDI Module (standard on *all Christie HD* models only and is optional for *Mirage* (or *Matrix*) models.)

NOTE: See **Appendix D – Optional Input Modules** for a brief description of each interface.

2.4 Connecting Communications

As an alternative to the projector’s keypad or remote, you may wish to communicate with the projector using a PC or other controller. Such a device sends commands and receives feedback via serial links (RS232 and RS422), Ethernet or GPIO communications to the projector, all described below.

Remote Keypads ▶ As desired, direct the projector’s IR remote keypad towards the display screen or the projector’s IR sensors. Alternatively, connect a wired (tethered) version of the remote to the 3.5mm RCA jack labeled as **REMOTE** on the projector’s input panel. Note that response to a wired keypad must also be enabled in the *Communications* menu—see **3.6, Adjusting System Parameters and Advanced Controls** for more information.

Serial Port Connections ▶ There are two types of serial ports available on the projector: RS232 and RS422. You can connect a device with a serial interface, such as a computer to either of these connectors (not both) and control the projector remotely by entering specific serial communication commands.

Connecting RS-232

The two nine-pin DIN connectors labeled RS232 IN and RS232 OUT on the input panel are dedicated to serial communication (see Figure 2.10). Using the appropriate serial communication cables (see **Appendix B**) connect the controlling source, such as a personal computer to the RS232 IN connector. Then set the baud rate to match that of the computer. Refer to **Section 3** for details on changing the projector’s baud rate.

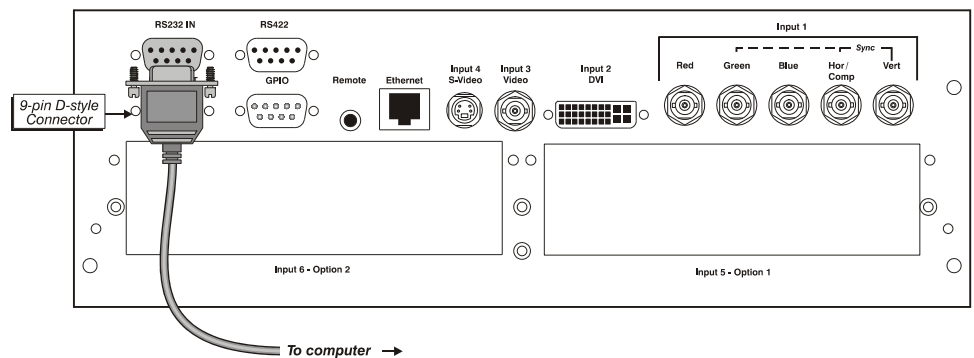

Figure 2.10. Connecting RS232

Connecting RS-422

If you wish to control the projector with a computer and or other controlling device with RS-422 capability, connect a RS-422 serial communication cable between the computer and the RS-422 port on the projector (see Figure 2.11). RS-422 is better suited for serial communication over long distances than is RS-232 communication.

⚠ Use the RS-422 port only if your device had RS-422 capability – always consult the literature provided with your equipment before connecting. Connecting to the RS-422 port with incompatible equipment could damage your projector.

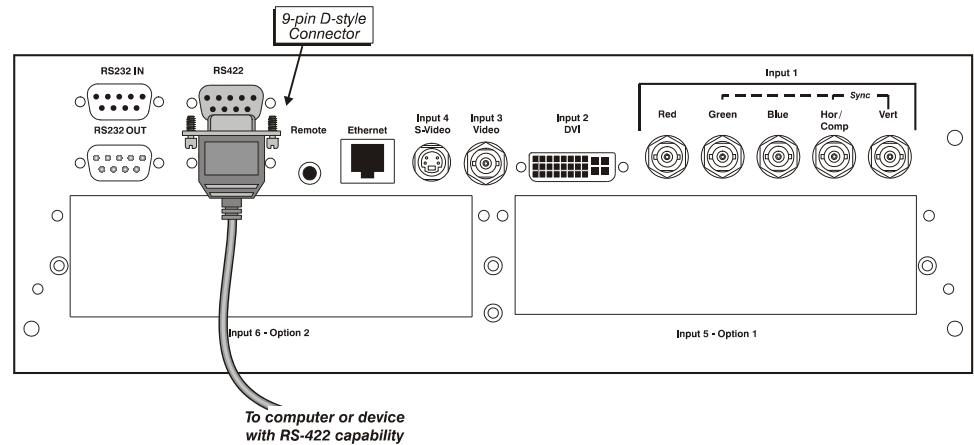

Figure 2.11. Connecting RS422

Ethernet Communications ► Ethernet Communications

To add the projector to an existing Ethernet network with other equipment such as controllers and other projectors, connect standard CAT5 Ethernet cable between your Ethernet controller (or hub) and the Ethernet port on the side of the projector.

Upon connection to an Ethernet network, the projector's factory default IP address of 0.0.0.0 will automatically enable the DHCP function (if available on the network) to assign a new IP address that is valid and unique for that network. Or, if there is no DHCP function available on the network (or if a specific static IP address for the projector is preferred or required), you can set the address in the *Ethernet Settings* menu or via an ASCII serial command.

Regardless of how it is assigned, once a projector has a valid and unique address it will respond to commands sent to this address. To determine the projector's current IP address, consult the *Status* or *Communications* menus.

Refer to **Section 3** for further information about setting up and using a projector connected via Ethernet.

Log on to www.christiedigital.com for detailed information on ChristieNET™.

Connecting Multiple Projectors ►

RS-232 NETWORK: If you want to connect multiple projectors in a network with serial communication, connect the controlling source to the RS232 IN connector of the first projector in the network. Then take another serial communication cable and connect one end to the RS232 OUT connector and the other end to the RS232 IN connector of the next projector. Continue this pattern of connection with all projectors in the network. The last projector in the network will only have a connection to the RS232 IN connector. See Figure 2.12.

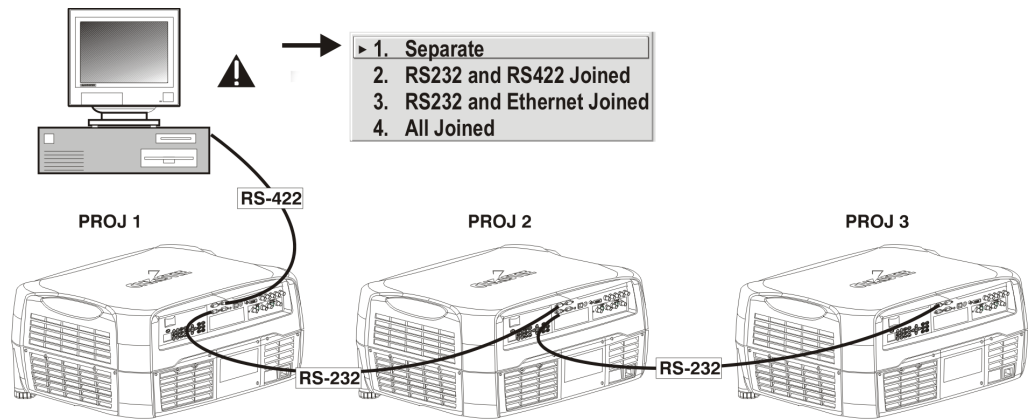

Figure 2.12. RS232 Network

MIXED NETWORK: To control multiple projectors with a computer/controller having an RS422 interface, first set them all to the same baud rate as your RS422 controller.

NOTE: You must enable this combination of RS422 and RS232 in the Communications menu. Set the “Network Routing” option to “RS232 and RS422 Joined”. See **Section 3** for details.

Then chain the projectors together by connecting an **RS232** port of the first projector (already connected to the computer/controller through the **RS422** port) to an **RS232** port on the next projector in the chain. Continue connecting projectors in this manner until you’ve reached the last projector in the chain, so that only the last projector has one unused **RS232** port.

Note that communication parameters such as baud rate must be set to match the particular controlling device *before* connecting as a network—refer to the documentation that came with your controlling device in order to determine the proper baud rate. See **3.6, Adjusting System Parameters and Advanced Controls** if you need help changing the projector baud rate. In addition, set the Network Routing to “RS232 and RS422 Joined” if you want to reach all projectors.

NOTES: 1) To avoid damage, connect only properly wired serial communication cables. See **Appendix B** for details. **2)** It is recommended that each RS232 communication cable be no more than 25 feet in length. Use high quality cables.

ETHERNET NETWORK SETUP: To add one or more projectors to an Ethernet network, use standard CAT5 cable to connect each projector’s Ethernet port to a hub belonging to the network. A controller or PC must also be connected to the hub. See Figure 2.13.

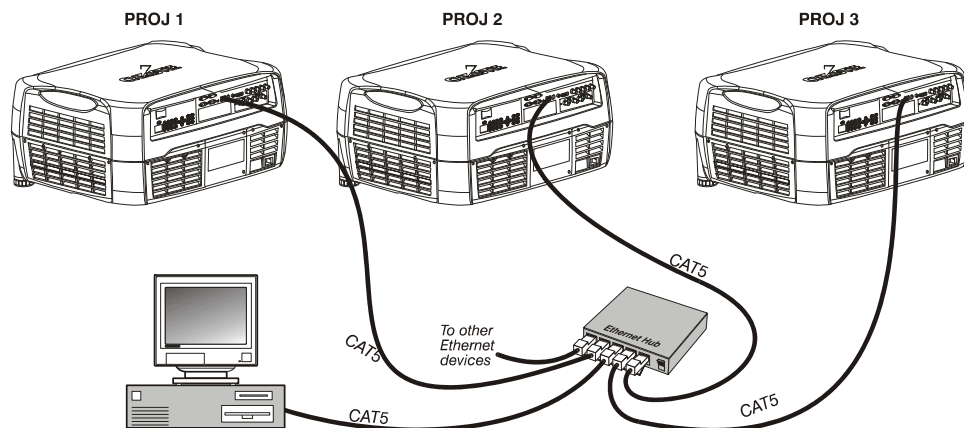

Figure 2.13. Ethernet Network

SETTING THE PROJECTOR'S IP ADDRESS: Upon connection to most Ethernet networks, each projector's factory default IP address of 0.0.0.0 triggers the network's DHCP (Dynamic Host Configuration Protocol) server function to automatically assign an IP address that is valid and unique for use on that network. Depending on the network, this DHCP-assigned IP address usually remains stable for a single session, but may change with subsequent power-ups and logins. On some networks, the address will remain stable from session to session. In all cases, the projector's IP address and port appear in the *Status* menu as well as the *Ethernet Settings* submenu. See Figure 2.14.

Ethernet Settings		
1.	DHCP Enabled	<input checked="" type="checkbox"/>
2.	IP Address	000.000.000.000
3.	Port	3002
4.	Subnet Mask	000.000.000.000
5.	Default Gateway	000.000.000.000
6.	Network Name	<input type="text"/>
7.	ArtNet Interface Settings	

= Projector's IP address will be DHCP-assigned
 = Use static address assigned in "IP Address"

Figure 2.14. Setting the Projector's IP Address

Note that if a projector's IP address is anything *other* than 0.0.0.0 (shown as 000.000.000.000 in the *Ethernet Settings* menu) upon connection to an Ethernet network, or if DHCP is not available on the network, the automatic DHCP server function for supplying a valid and unique IP address to the projector is disabled. Instead, a specific and static IP address must be defined in projector memory—enter the new address in the *Ethernet Settings* submenu, or send to the projector via a serial command. The IP address will be in effect until it is changed again, or until the DHCP checkbox is re-enabled for use with a DHCP server on the network.

CHANGING THE PORT#: On some Ethernet networks, firewall restrictions may require that the port number of the projector be changed from its default of 3002. If so, enter a new port number in the *Ethernet Settings* menu or include the new port# in an XIP serial command sent to the projector. It is highly recommended not to use a port# below 1024, as these ports are typically reserved for and used by common IP applications.

SUBNET MASK AND DEFAULT GATEWAY: The Subnet Mask and Default Gateway are automatically assigned when DHCP is enabled. If a static IP is being used, it must be assigned before the subnet mask. The Default Gateway is an optional router device used to send and receive data outside the subnet.

ArtNet INTERFACE SETTINGS: Refer to *Section 3.6 – Adjusting System Parameters and Advanced Control, System Configuration – Communication* for additional information about ArtNet settings.

Separating Networks ▶ By default, communications originating from one type of serial controller—RS232 vs. RS422 vs. Ethernet—stay on the corresponding network path. A “Separate” setting indicates this separation for “Network Routing” in the *Communications* menu. If you are using an RS422 controller, for example, it will communicate only with the projector to which it is connected unless you change this setting to either “RS232 and RS422 Joined” or “All Joined”.

Communicating to All Ports ▶ To relay all messages to all ports—RS232, RS422, and Ethernet—set the “Network Routing” option in the *Communications* menu for each projector to “All Joined”. This configuration is useful if you are using a non-RS232 controller with the RS232 linking available between these projectors. For example, you may want to use both an RS422-compatible controller and an Ethernet-connected PC for working with a network of projectors linked via their RS232 in/out ports.

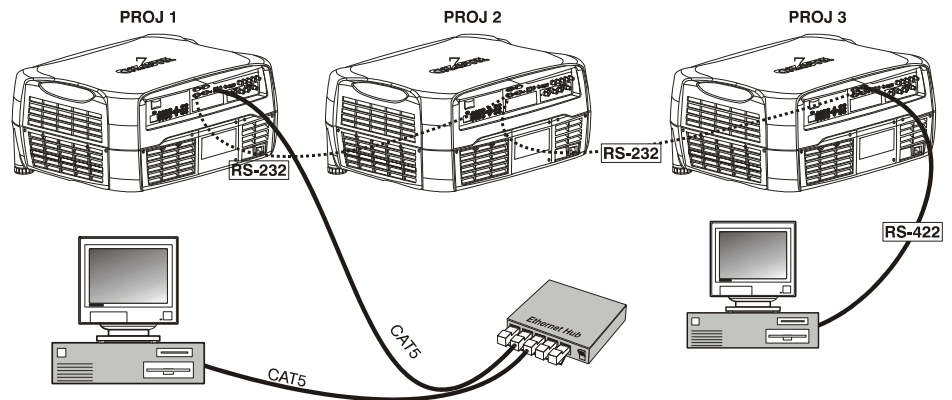

Figure 2.15. Joining All Networks

To isolate just RS422 communications, select “RS232 and Ethernet Joined”. In Figure 2.15, only projector #3 will respond to the RS422 controller. To isolate just Ethernet communications, select “RS232 and RS422 Joined”—only projector #1 will respond via Ethernet.

2.5 System Integration - GPIO Connector

The GPIO connector on the input panel can be used to provide a method of interfacing a wide range of external I/O devices to the projector.

Refer to Appendix C: System Integration for complete details on pin configuration and how to program the various pins on the connector.

2.6 Power Connection



The North American rated line cord is provided with each projector. Ensure that you are using a line cord, socket and power plug that meets the appropriate local rating standards.

Plug the line cord to the AC receptacle located at the back of the projector, below the input panel, and the three-pronged end into a grounded AC outlet. Ensure the socket outlet is installed near the equipment and is easily accessible. The input voltage to the projector must be capable of 100 – 240 VAC in 500W and 1000W models and 200-240VAC in 1200W models. (See also **Section 6 – Specifications** for complete details on all power requirements.)

Use the approved North American-rated line cord supplied with the projector. If you are connecting to an area outside of North America ensure an appropriately line cord rated for the region of use is used.

Always power down the projector before unplugging the AC line cord. Wait 5-10 minutes for the main exhaust fan to turn off and for the lamp to cool sufficiently before unplugging the projector.

WARNINGS

Do not attempt operation if the AC supply and cord are not within the specified voltage and power range.

Wait for the cooling fans to turn off before unplugging the projector.

Operation

3.1 About the Projector

This section explains how to effectively operate the projector once it has been installed. It is recommended that you read this section and familiarize yourself with the components and the available menu options before you begin using your projector for the first time.

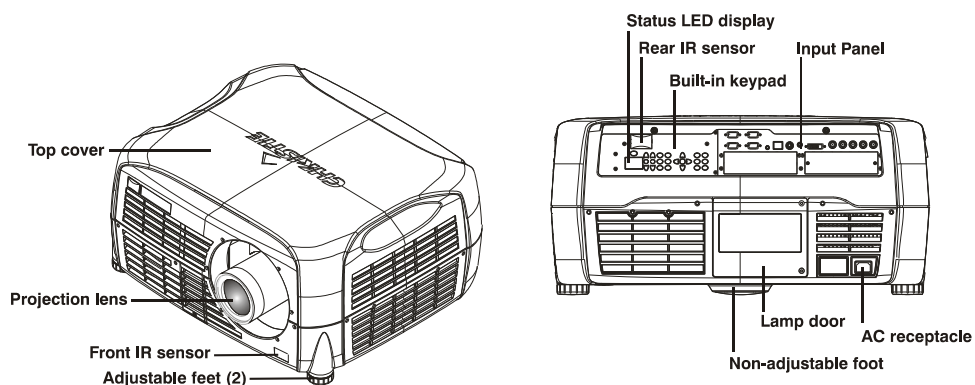

- Built-in Keypad** ► The built-in keypad is located at the back of the projector, beside the input panel. Use it similarly to the IR remote to control the projector. A status LED display is also included on this keypad for monitoring projector status.
- AC Receptacle** ► The AC receptacle is located at the back of the projector just below the input panel. Use this outlet to plug in an appropriately rated line cord. Refer to **Section 6 – Specifications** for details.
- Adjustable Feet** ► Located on the underside of the projector are two fully adjustable feet. Raise or lower these feet when positioning the projector to ensure it is level on all sides so the displayed image will appear rectangular without any keystone.

NOTE: *The third foot, located at the rear of the projector (underside) is not adjustable.*

Refer to **Section 2 - Projector Position and Mounting** for instructions on how to adjust the projector's feet.

Lens Mount & Projection Lenses

- ▶ The projector is built with a motorized lens mount that allows for easy lens control and adjustment. This includes such functions as adjusting vertical and horizontal offsets, zoom and focus. The lens mount can be fitted with any one of the available optional lenses – see *Section 6 - Specifications*.
- **Zoom and Focus** – There are two internal lens motors that allow for quick motorized adjustment of zoom and focus. Adjust zoom to fit the displayed image on the screen and adjust focus to improve the clarity of the image.
- **Lens Offset** – Vertical and horizontal offset is performed on the lens mount through the use of DC motors.
- **Shutter** – Standard on all models the shutter allows you to turn the screen absolutely black when in the “on” state.
- **Optical Aperture** – Enables adjustment of light output and contrast ratio.

NOTES: 1) *The projection lens is shipped separately from the projector.* 2) *Use the lens cap when transporting the projector to avoid scratching and damaging the lens, which could affect your displayed image.*

- Input Panel** ▶ All source connections are made to the input panel located at the back of the projector. Connect RGB or YPbPr sources to **INPUT 1**, analog or digital display signals to **INPUT 2**, composite video to **INPUT 3**, and S-video to **INPUT 4**. Any of the available optional modules can be installed in **INPUT 5** and/or **INPUT 6**.

There is no status display on the input panel. The only status display is part of the built-in keypad located at the rear of the projector.

- Cooling and Air Vents** ▶ There is numerous air vents located around the projector. It is important these vents remain unobstructed. Adequate airflow through the projector will prevent it from overheating.

- Front & Rear IR Sensors** ▶ The two IR sensors located on the projector receive transmissions from the IR remote from up to 100 feet away. It is important to keep the transmission path to these sensors unobstructed for uninterrupted communications with the projector. The front IR sensor is located next to the projector’s nameplate and the rear IR sensor is located at the back of the projector just above the status LED display.

- Lamp Door** ▶ The lamp door is located at the back of the projector, which provides easy access to the lamp module for replacement. See *Section 4* for lamp replacement procedures.

3.2 Using the Remote or Built-In Keypad

⚠ Laser radiation is emitted from the laser diode in the remote. Do not look directly into the beam of the remote.

Keypad Commands ▶ The projector is typically controlled using one of the following keypads:

- **Built-in Keypad** located at the back of the projector
- **Remote Keypad** for tethered or tether-less control up to 100 feet away (includes cable for use as a wired remote)

While each of the keypads provides complete control of the projector, they differ slightly in their arrangement of keys and in what functions can be accessed directly with a key press rather than requiring use of the menu system. You may find one keypad more convenient than another for your specific installation and application.

NOTE: *The remote keypad has a single IR protocol and can be converted to a wired remote by connecting the cable provided with the projector to the RCA jack labeled as REMOTE on the input panel.*

Built-in ▶ To control the projector when signals from a remote keypad cannot reach the projector, use the projector’s built-in keypad (Figure 3.1). The nearby LED display provides feedback indicating current status and activities of the projector, (see Table 3.1). Because the built-in keypad has fewer keys than the remote keypad, certain projector functions are accessible only through the menu system rather than via a direct key.

NOTE: *The built-in keypad cannot be disabled.*

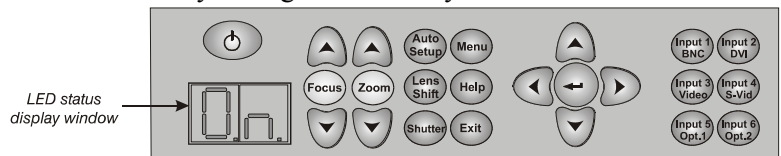

Figure 3.1. Built-in Keypad

Refer to the key descriptions provided for the IR remote – see Figure 3.2.

IR Remote ▶ The IR remote keypad controls the projector by way of wireless communications from a battery-powered infrared (IR) transmitter. Use the IR remote keypad the same way you would use a remote keypad supplied with a TV or VCR. When making key presses, direct the keypad either toward the screen or toward the front or rear of the projector. One of the two IR sensors on the projector will detect the signals and relay the commands for internal processing.

TABLE 3.1 – LED Status Display ▶

LED STATUS DISPLAY:	DESCRIPTION
--	AC power supplied, projector Off
On	Projector On
LC	Lens calibration in progress
LP	Lamp has reached defined "Lamp Limit" refer to 3.9 Working with the Lamp
SH	Closed shutter
# #	System warning or error has occurred
— —	Cooling down (Rotating Horizontal Bars)
— —	Power to Off state or Powering up (segments spinning clockwise)

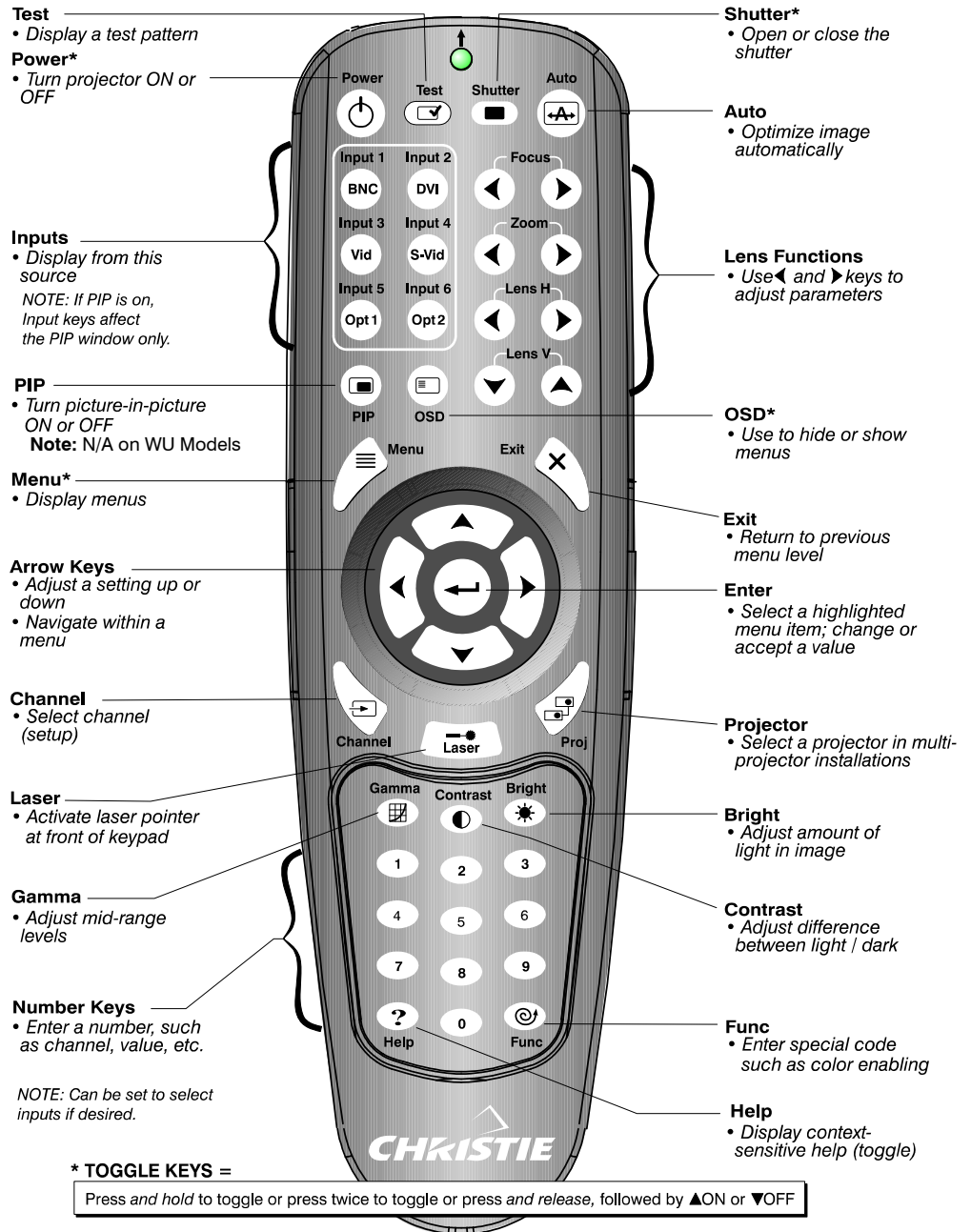

*These are toggle keys, which require you to press and hold or press twice or press and use the up/down arrow keys.

NOTE: To turn the OSD off you must press and .

Figure 3.2. Remote Keypad

Wired Remote ▶ You can convert the IR remote into a wired remote keypad using the cable provided with the projector. Connect one end into the remote and the other to the mini stereo connector on the input panel labeled as **REMOTE**. The wired remote is recommended when:

- The built-in keypad is inaccessible
- The lighting conditions are unsuitable for proper IR transmission





NOTE: Leave the batteries in the wired remote for the laser key (↔) to work.

Guide to Keypads ▶ Keep in mind the following guidelines:

- Press keys one-at-a-time; there are no simultaneous key combinations required.
- Note that the two keys—Power (⏻) and Shutter (Shutter) are “press-and-hold” keys that do not function with a typical quick press-and-release key press (see Figure 3.2).
- Hold arrow keys down for continuous adjustment/movement in one direction. In serial networks, pause briefly between adjustments to ensure that more distant projectors can “keep up” with the commands.
- If you press a key while the projector is still responding to the previous action, such as during power-up, the second key press may not take effect.





Keypad Commands ▶ Specific keypad commands are explained below:

 **Power ON/OFF**

Press *and hold*  for two seconds or press twice quickly to toggle the projector (on) or (off) with a single keystroke. Or press and release  followed immediately by  (on) or  (off) to guarantee the correct toggle (useful if you are unsure of the present state).

NOTES: 1) After powering down, the lamp cooling fan remains on for approximately five minutes to cool the lamp. **2)** It is a good idea to avoid turning a projector back on until it has been off for a few minutes. Hot re-strikes of the lamp may reduce lamp life.

 **Test**

Press  to step forward through all internal test patterns and this will eventually lead you to the current input. If you press  and then cycle by using the  and  right arrow keys, you’ll be cycling in either direction through the test patterns only, no input.

 **Auto**

Press  to initiate an automated process in which the projector optimizes critical display parameters such as size, position, pixel tracking, etc., for the current source. These parameters are listed in Table 3.1. An *Auto Setup* can save time in perfecting a display and you can modify the adjustments as desired.

Table 3.1. Auto Setup

What an “Auto Setup” Does	
OPTIMIZES:	SETS TO DEFAULT:
Pixel Tracking	Contrast
Pixel Phase	Brightness
Size and Blanking	Auto Input Level (off)
Vertical Stretch	Detail (if video source)
Position	Filter
Input Levels	Luma Delay

NOTE: You must have an unlocked channel present to use Auto Setup.



Channel

Press to select a specific source setup (*channel*) defined and stored in projector memory. Once you enter a two-digit channel number (or, if there is a list displayed, highlight it and press) , the display will automatically change and update according to the numerous setup parameters defined for that channel. Note that a new channel is automatically created if you adjust an image from a new source.

NOTE: Channel key behaviour during a presentation depends on whether or not the **Display Channel List** option is enabled in the **Menu Preferences** menu. You can choose to use a scrollable list of channels when you press , or you may prefer to enter the desired channel number “blind”, i.e., without on-screen feedback. See **Menu Preferences** later in this section.



Input 1

Press to display from the data input source connected to BNCs labeled **INPUT 1**.



Input 2

Press to display from the DVI source connected to **INPUT 2**.



Input 3

Press to display from the composite video source connected to **INPUT 3**.



Input 4

Press to display from the S-video source connected to **INPUT 4**.



Input 5

Press to display from the **INPUT 5** interface module installed in the Option 1 slot.

NOTE: If you have the optional Dual SD/HD-SDI Module installed and there are two inputs connected here, the second input (B) is considered **INPUT 7**. If you are using the built-in keypad or the remote keypad, press **INPUT 5** to access **INPUT 7** as follows:

- While displaying from **INPUT 5**, press again. This switches to **INPUT 7**.
- While displaying from any input other than the Dual SD/HD-SDI Module, press , this switches to either **INPUT 5** or **INPUT 7**, depending on which of the Dual SD/HD-SDI Module inputs (A or B) was last used. Press again to display from the other Dual SD/HD-SDI Module input.



Input 6

Press to display from the **INPUT 6** interface module installed in the Option 2 slot.

NOTE: *If you have the optional Dual SD/HD-SDI Module installed and there are two inputs connected here, the second input (B) is considered **INPUT 8**. If you are using the built-in keypad or the remote keypad, press **INPUT 6** to access **INPUT 8** as follows:*

- *While displaying from **INPUT 6**, press again. This switches to **INPUT 8**.*
- *While displaying from any input other than the Dual SD/HD-SDI Module, press , which switches to either **INPUT 5** or **INPUT 8**, depending on which of the Dual SD/HD-SDI Module inputs (A or B) was last used. Press again to display from the other Dual SD/HD-SDI Module input.*



Contrast

Press to change the amount of white in your images. Use keys until you reach the desired level of contrast—for best results, start low and increase so that whites remain bright but are not distorted or tinted and that light areas do not become white (i.e., “crushed”). Conversely, low contrast causes dim images. See 3.5, *Adjusting the Image* (Image Settings subsection).



Brightness

Press to increase or decrease the amount of black in the image. Use keys until you reach the desired level of contrast—for best results, start high and decrease so that dark areas do not become black (i.e., “crushed”). Conversely, overly high brightness changes black to dark gray, causing washed-out images. See 3.5, *Adjusting the Image* (Image Settings subsection).



Gamma

“Gamma” determines how gray shades are displayed between minimum input (black) and maximum input (white) for a given amount of signal. The proper setting helps maintain optimized blacks and whites while ensuring a smooth transition for the “in-between” values utilized in grays. Unlike brightness and contrast controls, the overall tone of an image can be lightened or darkened without changing the two extremes and your images will be more vibrant yet with good detail in dark areas when using the Gamma control.

The normal gamma setting of 2.2 is correct for most signals and conditions. If excess ambient light washes out the image and it becomes difficult or impossible to see details in dark areas, lower the gamma setting to compensate. This will improve contrast ratio while maintaining good details for blacks and whites



Menu

Press to enter or exit the projector’s menu system.

OSD (On-screen display)

Press **OSD** **▼** to hide the projector’s menu system during use. To see the menus again, do one of the following:

- Press and hold **OSD** for two seconds
- Press and release **OSD** followed immediately by **▲**
- Press **OSD** **OSD**

Invisible menus are fully functional, enabling “hidden” access to numbered features and image adjustments by entering the corresponding sequence of key presses on the keypad.

NOTE: *With OSD “on”, you can still hide error messages and slide bars by disabling these options in the **Menu Preferences** menu.*

Shutter

Press and hold **Shutter** for two seconds to toggle the internal mechanical shutter blade closed or open with a single keystroke. Or press and release **Shutter** followed immediately by **▲** (closed) or **▼** (open) to guarantee the correct toggle (useful if you are unsure of the present state). Alternatively, press **Shutter** **Shutter** to toggle from the present on/off state. A closed shutter blanks the display (turns it to black). Close the shutter to mute all display while maintaining access to projector functions. Opening the shutter restores the image.

NOTES: **1)** *The status display shows “5H”, when the shutter is closed.* **2)** *The shutter is open upon power-up.*

Function Key

IF WITHIN A MENU: Using the **Func** for special tasks within the menu system is noted with the appropriate topic elsewhere in **Section 3**. For example, press **Func** in the *Channel Setup* menu to enable deletion or copying of a channel.

IF WITHIN A PRESENTATION: Press **Func** followed by a two-digit number to enable a specific color or colors in the display (see right). For example, **Func** **6** **4** will display only red and green data, **Func** **6** **7** will display all color data. Eliminating one or more colors can help with certain diagnostics and setups, such as when accurately overlaying one image on top of another from stacked projectors.

- Func** **6** **1** = Red
- Func** **6** **2** = Green
- Func** **6** **3** = Blue
- Func** **6** **4** = Red & Green
- Func** **6** **5** = Green & Blue
- Func** **6** **6** = Red & Blue
- Func** **6** **7** = All Colors



NOTE: *Color enabling can also be implemented from numerous locations within the menu system.*

Projector

Press **Proj** to access a specific projector within a group of projectors or to confirm if the local projector is listening. The number in the “Enter Number” window indicates which projector is currently listening to commands, and will match the projector number that has been defined in the *Menu Preferences* menu.

The “Projector” checkbox (read-only) shows whether or not the projector physically connected to a keypad is listening to commands from that keypad. A checkmark means that connected projector is listening; if there is no checkmark, you are communicating with a different projector.

To control a specific projector with the keypad, press  and then enter the three-digit number assigned to the projector you want to use. If you switch to a projector other than the one you are currently using, the checkmark will disappear.

To broadcast to multiple projectors, press  and then  again *without* entering a projector number. Keypad commands will then affect all projectors present. Note that there is no method of controlling a *group* of projectors within the same wired configuration using the wired keypad exclusively, since there is only one wired protocol available.

NOTES: 1) The “Broadcast Keys” option in the Communications menu must be selected for only *one* (any) projector in a serial network. The keypad in use must be OFF (disabled) for the remaining projectors. **2)** See 3.6, *Adjusting System Parameters and Advanced Controls*.





Enter

Press  to select a highlighted item, to toggle a checkbox, or to accept a parameter adjustment and return to the previous menu or image.





Exit

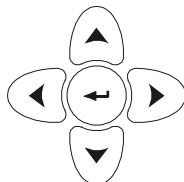

Press  to return to the previous level, such as the previous menu.

NOTE:  does not save changes within text editing boxes (including number editing of a slide bar value) or within pull-down lists. It acts as a “cancel” in these cases.







Arrow Keys









Use the   keys to change a slide bar value or to select a different option within a pull-down list without having to first scroll through options. See also *Editing Text* later in **Section 3**.

Use the   keys to navigate within a menu, pull-down list or text box.



Lens Focus, Zoom and Lens H, Lens V

When adjusting the image for focus, zoom, horizontal and vertical positioning, use the specific arrow keys (/  or / ) related to each function. A small window will appear to indicate the type of adjustment taking place. For example,

- Use the “Focus”  or  keys to improve image clarity as desired.
- Use the “Zoom”  or  keys to achieve a desired image size.
- Use the “Lens H”  or  keys to position the image horizontally while still keeping it rectangular.
- Use the “Lens V”  or  keys to position the image vertically while still keeping it rectangular.

Press  to return to presentation level.

NOTE: Use the key (built-in keypad) with the general keys to get the same effect as if using the arrow keys related to “Lens V” or “Lens H” on the IR remote.



Laser

Press to activate the laser pointer on the remote. This feature is useful when making presentations - just point the remote at the screen to highlight an area of your presentation. The closer you are to the screen the brighter the laser beam appears. The laser pointer works best in an environment where ambient lighting can be controlled.

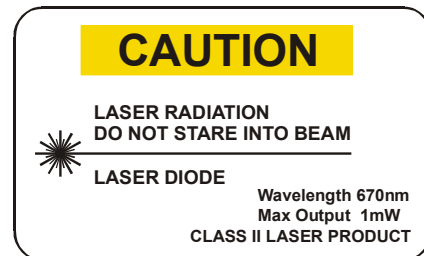

NOTE: Leave batteries in the wired remote keypad for the key to work.

3.3 Navigating the Menus

Most of the controls for the projector are accessed from within the projector’s menu system. There are several groups of related *functions*, with each group selectable from the *Main* menu as shown at right. Press at any time to display this *Main* menu.

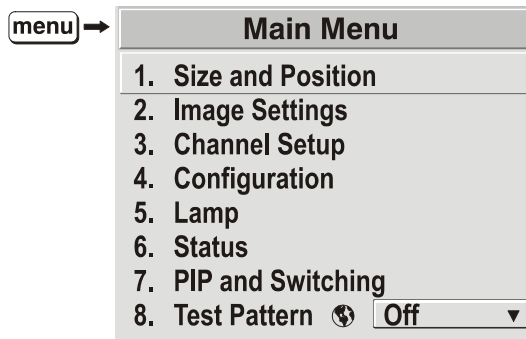

On the remote keypad, either enter the number corresponding to the function menu you wish to access, such as for the *Image Settings* menu, or use the keys on any keypad to highlight the desired option, then press . The corresponding function menu or pull-down list of further options will then appear.

With a function menu displayed, navigate in a similar manner—enter a menu option number for any numbered option, or use the keys to highlight the desired option and then press (Enter). Extra long menus have a scroll bar on the right—use the arrow keys to access the remainder of the menu. Locked items or items that do not pertain to the current action or condition appear dimmed and cannot be selected.

NOTES: **1)** *If there is no signal present, all source-dependent adjustments are disabled.* **2)** *After 15 minutes of inactivity, the projector leaves the menu system and returns to the presentation.* **3)** *The **Status** menu is read-only.*

When finished with a function menu, do one of the following:

- Press to return to the previous screen
- Press to leave the menu system and return to the presentation

On-line Help ▶ If at any time you are uncertain what to do next, press **Help** to display summary information about the current menu or highlighted option. Press **Help** again to exit. In addition, a line of “hint” text is included at the bottom of some menus.

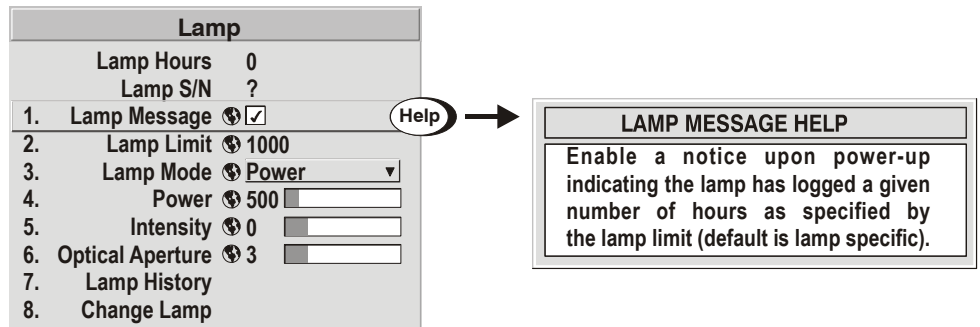

Press **Help** from the presentation level to access general *Help Topics*. Scroll as necessary within a topic; press **Help** or **Exit** to return to your presentation.

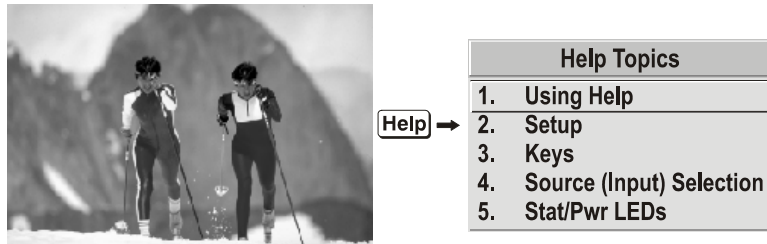

Time-outs ▶ If a slide bar, menu, or message is displayed, you have limited time in which to make a keypad entry before the projector returns to presentation level **Help** and the graphic disappears. These time-outs may vary depending on what is displayed.





The Global Icon ▶ Menu options that include this icon apply universally to any incoming signal.



Using Slide bars and Other Controls ▶ Most of the function menus allow you to change settings by using slide bars, checkboxes, and pull-down lists. To select a slide bar, toggle a checkbox status, or view a pull-down list, do one of the following within the function menu:







- Enter the menu option number corresponding to the setting you wish to change (for example, press **Menu** **1** **3** to select “Vertical Stretch” in the *Size & Position* menu).
- Move the highlight to the option desired and press **Enter**.
- Move the highlight to the option desired and press **Left** **Right** to adjust immediately.
- Bypass the menus entirely and use a single key to immediately access an adjustment during your presentation (applies only to options having their own key, such as Contrast, Brightness, Gamma, etc.).
- For “blind” access, hide the entire menu system (see OSD key, above) and/or direct slide bars activated by their own key (such as Contrast, Brightness, etc.). Control by using the proper key press or numerical sequence of key presses.

Once selected, change the setting as desired (see below) and press  to save and return to the current function menu.



Slide bars in menus – The current value for a given parameter, such as size or vertical stretch, appears to the left of its slide bar icon (adjustment window). This number often expresses a percentage, or it may have units associated with it (such as pixels, degrees Kelvin, etc.), depending on the specific option. Press   to gradually adjust the setting up or down—both the number and the length of the bar change accordingly. Hold for continuous adjustment. Or press  to activate a slide bar text box for specific number entry via the keypad and then press  to save (or press  to cancel).



“Direct” slide bars - For quick access, you can access Gamma, Brightness, and Contrast slide bars without traveling the menu system. For example, simply press  to immediately display the same contrast slide bar accessed with the Contrast option in the *Image Settings* menu.

Use the arrow keys to adjust a direct slide bar, or press  and enter a specific number from the keypad, then  or  or  to save (or  to cancel). When you are done, press  to save and return to your presentation.



NOTES: 1) *You can still adjust a direct slide bar as usual if the display is turned off (see  or **Menu Preferences** menu) — the slide bar just won't be visible. 2)* *A direct slide bar disappears if it is not used within five seconds.*

Checkboxes - Conditions are present if its adjacent checkbox contains a checkmark. To toggle the checkbox, simply highlight and press , or highlight and use  to check and  to uncheck. If a checkbox is numbered, simply enter its number to immediately toggle the checkbox.



Pull-down lists – To see a pull-down list of options available for a given parameter labeled with a ▼, you can:

- Highlight it and press  (Enter)
- Enter the menu option number

Use the  or  keys to navigate up and down within the list (the current choice is noted with a small arrow below). Press  to choose an option from the list, if desired (see Figure 3.3).

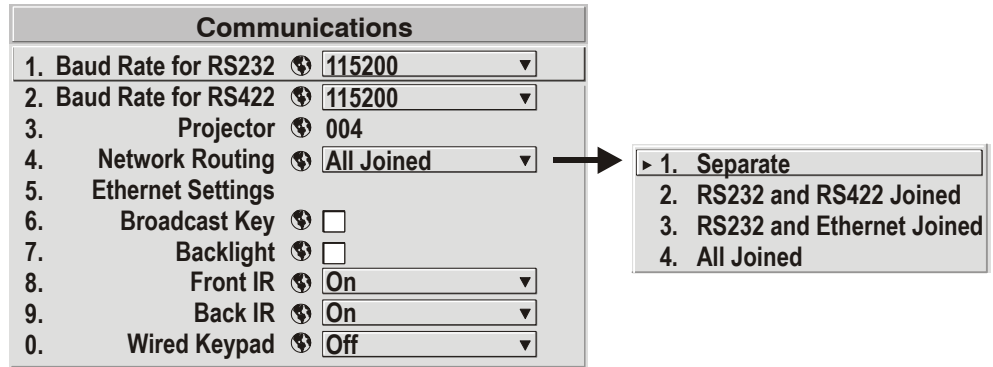

Example of Pull-Down List

If you prefer to quickly scroll through a list without first pulling it down, highlight the option and use \leftarrow or \rightarrow . Press \leftrightarrow when the desired choice appears.

NOTES: 1) Press \leftarrow or \rightarrow to jump between pages in an extra long pull-down list. 2) Press Exit while in a pull-down list to **cancel** any change.

Editing Text ▶ **ACTIVATE THE EDIT WINDOW:** To enter or edit text, highlight the desired parameter (such as a channel name) and press \leftrightarrow to activate its adjacent edit window. Any previously entered text is displayed with its first character highlighted in a square cursor, signifying that this character is ready for editing.

NAVIGATE WITHIN THE EDIT WINDOW: Press \rightarrow to move the cursor forward or \leftarrow to move the cursor backwards as desired.

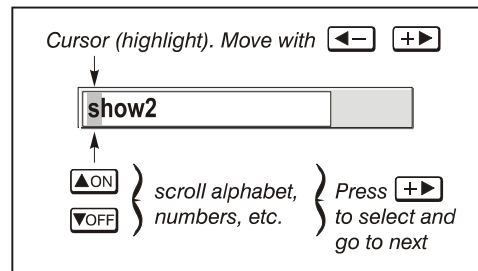
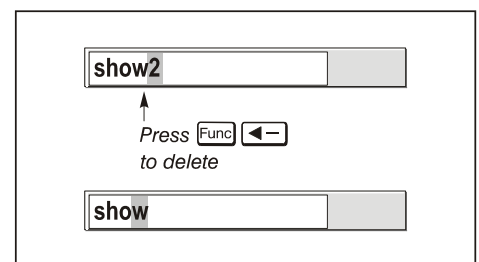
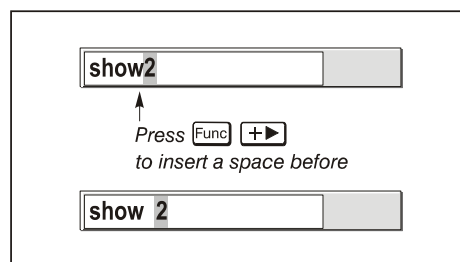

Figure 3.3. Entering Text

EDIT A CHARACTER: To edit a highlighted character, use \uparrow and \downarrow to scroll through the alphabet, numbers, spaces and punctuation available. When the character you need appears, press \rightarrow to select it—the cursor will move to the next character of current text, if present. Note that you can also enter a number directly from the keypad—it will be accepted and the cursor will move on.

ADD OR DELETE A CHARACTER OR SPACE: To insert a space at the cursor location, press Func \rightarrow . To delete a highlighted character (or space), press Func \leftarrow .



PRESS \leftrightarrow (ENTER) WHEN FINISHED: To accept edits and leave the edit window, press \leftrightarrow (Enter).

NOTE: Press  at any time to cancel changes and return to the previously defined text.

- Editing Numerical Values** ▶ Enter numbers directly from the keypad in order to specify numbers representing projectors, channels (source setups), or slots. As each digit is entered, it is displayed and the cursor moves on. Note that channel numbers are defined with two digits—for example, if you enter only a single digit (such as “7”) for a channel number, the channel will automatically be defined as “07”. Enter “07” to utilize this channel.







NOTES: **1)** Once you enter the first digit, this digit replaces all old digits. **2)** If you press any non-numbered key, the number entered up to that point is accepted and updated as the new value. **3)** Press  to cancel editing of numerical values.

3.4 Using Inputs and Channels

NOTE: See *Section 2, Installation and Setup*, for a full explanation of how to connect sources to the projector.

The projector stores and automatically recalls up to 50 different channels (source setups) for a variety of inputs. This memory feature allows you to define and conveniently use a wide variety of customized setups rather than having to repeatedly re-configure the projector for different presentations. Depending on what you have defined, each physical source connection (i.e., input at the projector) can have several different channels associated with it.

- Do I Select an Input Or a Channel?** ▶ **INPUT** – An input is a source physically connected at the projector.  Describes the source signal according to which *input slot* it is connected.

SWITCHING INPUTS – Press the appropriate direct key — , , , ,  or  to quickly display from one of the six inputs connected to the projector. The image will be displayed according to the following:

If it is the first time you have used the source/input (or if you used the input but did not define a channel by adjusting anything), the projector will recognize the new input signal based on its frequencies and polarities, and will automatically display an image according to default settings for such a signal. In general, the image from the new source will be as large as possible without losing its aspect ratio. This and other default image settings depend on the incoming source.

If you used the source once before and changed a display parameter such as contrast, V-Position, etc., then a channel was automatically created and still exists in projector memory (see below). Using one of the  keys will automatically recall this channel—and all its setup parameters—and update the display accordingly.

If more than one channel exists for the input, the image will be displayed according to the setup parameters for the first channel with matching characteristics.

NOTE: *Inputs 7 and 8 require the Dual SD/HD-SDI module in either of the projector’s option slots. For their selection, see also 3.2 Using the Remote or Built-In Keypad.*

CHANNEL - A channel is a collection of measurements, locations and settings that tailor the display of a signal to your specific needs. Since source types and applications can vary greatly, you will likely want to adjust and define a wide variety of parameters, such as brightness, contrast, size, etc., in order to customize and optimize the display from or for a particular source. For example, the display settings

you choose for a VCR source may be very different from those you choose for a high-resolution computer source, or one signal may simply vary from another signal used previously through the same input location. Once you have adjusted a display parameter, such as pixel tracking or contrast, all current settings are collectively stored in the projector's memory as a unique two-digit channel, such as 09. You can have numerous distinct channels available for the same input, any of which can be selected by using the Channel key on the keypad followed by the two-digit channel number.

Shown at right is a sample channel list as would be available from Channel. This is typically called the *channel list*.

NOTE: The Channel key may display a channel list or not, depending on what you have defined for "Display Channel List" (see *Menu Preferences* later in this section).

chan		Channel: 02			
01	0,2	pDig	64.09k+	60.12+	
02	0,1	i3LG	33.72-	59.94-	
03	0,4	iSVid	15.73k-	59.94-	
04	0,3	pCVid	15.73+	59.94+	
05	0,1	p4WH	Fred's computer		

↑ channel# ↑ signal type ↑ H and V frequencies, or channel name

Channel List

In order to access channels by using Channel on the keypad, you must first create the channels. See below.

Creating a New Channel – AUTOMATIC –

To use a new source with the projector, a new channel must be added to projector memory so that the projector will respond properly to an input signal from that source in the future. A new channel can be created automatically, as described here, or it can be copied from an existing channel and then edited as necessary (see *Copying or Deleting Channels* later in this section).

When you select a direct input (Input 1, Input 2, Input 3, Input 4, Input 5 or Input 6), any existing channels in the projector are searched for matching input and signal parameters – this only occurs if Auto Source is enabled on these channels. If no match to the incoming input signal is found in currently defined channels, a new channel is temporarily created based on factory-defined defaults for this type of signal. The *channel number* assigned is the lowest available number from 01-50.

NOTES: **1)** An automatic channel will be discarded unless one or more of its parameters are changed and will not appear in the channel list (see below). **2)** If two channels have the same distinguishing source characteristics except for the reversal of sync connectors (i.e., H-sync and V-sync, are switched), they are still defined as distinct channels. **3)** You cannot define a new channel without an incoming signal.

If the incoming signal *does* match an existing channel, the image will be set up and displayed as usual according to the parameters currently defined for that channel.

USING A CHANNEL: You can normally select a channel at any time by pressing Channel (see right). If you want to prevent a channel from appearing in this list, you must edit the channel as described in *Channel Edit* later in this section. Such a channel can still be selected by entering its number as shown at right.

NOTES: 1) The current channel is highlighted upon entering the channel list, or, if this channel is not displayed here, the first channel in the list is highlighted. 2) Channels created automatically do not appear in the channel list unless a parameter for the channel has been changed.

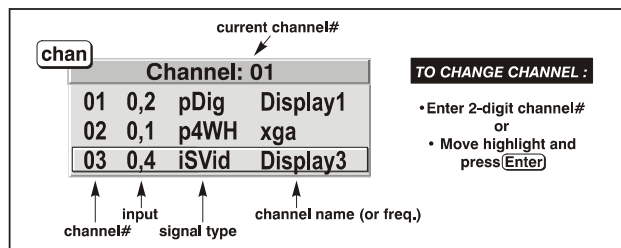

What Channels Are Defined So Far?

▶ All available channels are listed in the *Channel Setup* menu, which describes how each channel can be accessed and which serves as the gateway for editing, copying and deleting channels.

Press **Menu** from the presentation level to display the *Main* menu. To display the *Channel Setup* menu, press **3**, or move the highlight to the *Channel Setup* option and press **Left Arrow**. The *Channel Setup* menu will appear (see sample at right), with the active channel highlighted.

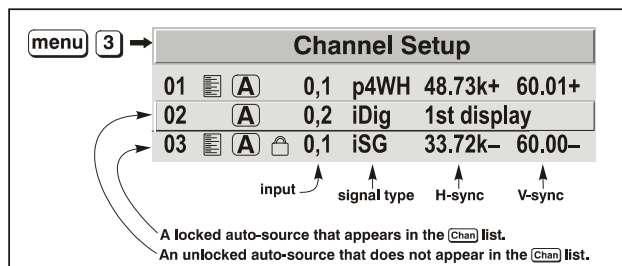

All Channels Appear in the Channel Setup Menu

WHAT APPEARS IN CHANNEL SETUP MENU? This menu lists all channels defined so far and indicates where they are connected on the input panel. The far left column lists channel numbers currently defined. The values in the far right columns indicate horizontal and vertical frequencies—if someone has defined a name for this channel, it appears here instead. Remaining columns contain details pertaining to each channel setup, such as its switcher number (always 0 = projector), slot location, a variety of icons indicating access to each channel, and an abbreviated description of each signal type. See *Editing a Channel Setup* for details.

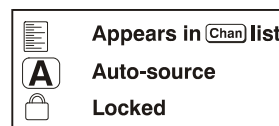

NOTE: If you have more than a handful of channels, use **Left Arrow** and **Right Arrow** to see the remaining channels not visible in the initial display of channels.

SIGNAL TYPE — Either channel list, whether the **Channel** key list or the *Channel Setup* menu, identifies signal types in a shortened form as defined below. These descriptors indicate what signal information the projector uses to identify a match for a given channel, and are preceded by either an “i” (interlaced signals) or “p” (progressive signal“). See Table 3.2.

Table 3.2. Abbreviations for Signal Type

Abbrev.	Signal Type
4WH	Composite (4 wire) on HC input
4WV	Composite (4 wire) on V input
SG	Sync-on-green
5W	Separate H,V
5WR	Separate H,V swapped
SVid	S-Video
CVid	Composite Video
Dig	Digital

FUNCTIONS WITHIN THE CHANNEL SETUP MENU —To copy, delete or edit a channel, highlight the desired channel in the *Channel Setup* menu and do one of two things:

- Press **Func** if you want to copy the selected channel or delete this or other channels. See *Copying or Deleting a Channel* below.
- Press **←** if you want to edit channel setups (i.e., non-image related parameters) for the selected channel. See *Editing a Channel Setup*, below.

Copying or Deleting Channels

► **TO COPY A CHANNEL**, highlight the desired channel in the *Channel Setup* menu, then press **Func** to go to the *Channel Copy/Delete* submenu. Select “Copy” and press **←**—a new channel will be created. It is identical to original, which still remains, but it is identified with the next available number from 01-50. If you change your mind and do *not* want to copy the current channel, press **Exit** to cancel and return to the previous menu. Copying channels is a quick method for creating numerous channels, each of which can then be edited and adjusted for a variety of presentations in the future. See Figure 3.4.

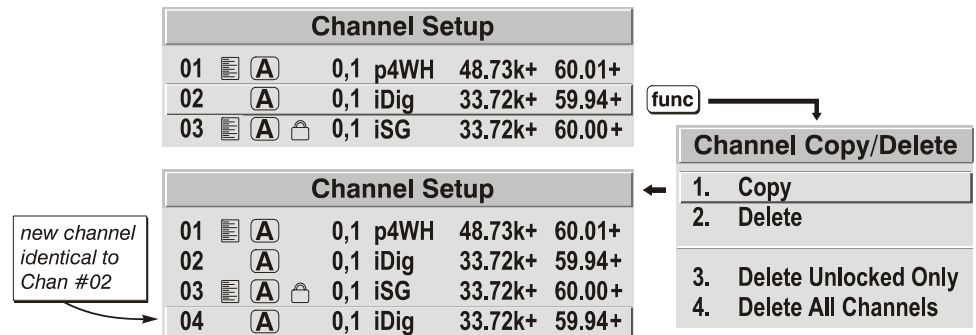

Figure 3.4. Copying A Channel

TO DELETE A CHANNEL, highlights the desired channel in the *Channel Setup* menu, then press **Func** to activate the *Channel Copy/Delete* submenu. Select “Delete” and press **←**—a window will appear to confirm the deletion of this channel. See Figure 3.5.

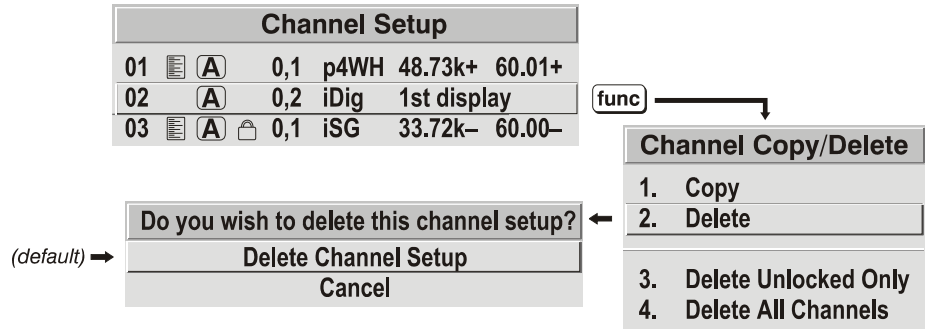

Figure 3.5. Deleting a Channel

TO DELETE MULTIPLE CHANNELS highlight any channel in the *Channel Setup* menu and press **Func** to go to the *Channel Copy/Delete* submenu. Select “Delete Unlocked Only” and press **←** to delete all unlocked channels. Select “Delete All Channels” to delete all channels, even those that are locked. In either case, the current channel will remain but will be redefined from projector defaults.

NOTE: For any deletion, a window will appear to confirm the deletion of the desired channel. Select “Cancel” (default) if you don’t want to delete after all.

Editing a Channel Setup

- ▶ The basic setups that describe how and where a channel can be accessed are listed in the *Channel Setup* menu. These channel setups can be edited at any time in the Channel Edit submenu.

CHANNEL EDIT — STEP 1 Press **Menu** from the presentation level to display the main menu. To display the *Channel Setup* menu, press **3**, or move the highlight to the *Channel Setup* option and press **←**. The *Channel Setup* menu will appear.

CHANNEL EDIT — STEP 2 To edit parameters shown in the *Channel Setup* menu, select the relevant channel and press **←**. The *Channel Edit* menu will appear similar to the sample shown below.

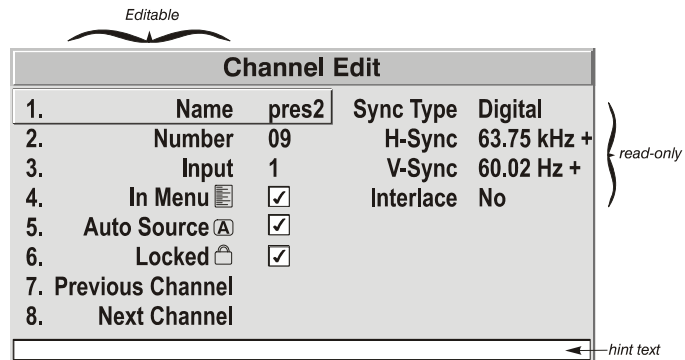

Channel Edit Menu (SAMPLE)

CHANNEL EDIT — STEP 3 If desired, review and/or edit the following channel setups in the *Channel Edit* menu:

- **CHANNEL NAME:** An alphanumeric label can be defined and/or changed here. Channel names can be up to 12 characters in length.
- **CHANNEL NUMBER:** A two-digit channel number can be changed here.

NOTES: 1) If you enter a channel number that already exists; a dialog message appears indicating that this number is already in use—assign a different channel number. **2)** You can define up to 50 channels.

- **INPUT:** 1-8, corresponding to where on the projector’s input panel the source is connected.
- **IN MENU:** If checked (default, except for automatically defined channels with unchanged parameters), this defined channel will then appear in the list available when **Channel** key is pressed. If unchecked, the channel must be accessed via **Channel** on the keypad or via the Auto Source function.

NOTE: On-screen display of the channel list is an option that must be set in the **Menu Preferences** menu.

- **AUTO SOURCE:** If checked, (default), the projector can automatically locate this channel when an incoming input signal matches. If not checked, the projector can locate the selected channel only when it is directly selected via **Channel** on the keypad—and a change in input signal will *not* result in a channel change.
- **LOCKED:** If checked, all of the image settings for this channel are disabled. If unchecked (default), all available image settings can be adjusted as desired. You cannot use Auto Setup with a locked channel.
- **PREVIOUS CHANNEL:** Select this option to see or change *Channel Edit* settings for the previous channel in the *Channel Setup* list.
- **NEXT CHANNEL:** Select this option to see or change *Channel Edit* settings for the next channel in the *Channel Setup* list.

3.5 Adjusting the Image

The most commonly used options for image adjustments are accessed through two menus: *Size and Position* (**Menu** 1) and *Image Settings* (**Menu** 2), both of which appear in the *Main* menu. From either of these two menus, you can change settings affecting the image from the current channel by working with the appropriate slide bars, checkboxes and pull-down lists. **Exit** will return to the previous menu (or to the presentation, if from the *Main* menu) and accept any changes you may have entered. Settings are saved with the current channel.

From your presentation, you can access any of the individual options in these menus by pressing **Menu** followed by the appropriate two-digit number representing their location in the menu system. For example, press **Menu** 2 3 to quickly access the “Gamma” option in the *Image Settings* menu.

Note that for certain options, you may prefer to use a “direct key” from presentation level to go directly to a particular option without traveling through the menu system (*available for certain display parameters only*). For example, press **Contrast** to access the “contrast” slide bar immediately. Press **Exit** to return to your presentation.

NOTES: 1) To hide these “direct” slide bars, disable the “Display Slide bars” checkbox in the **Menu Preferences** menu. **2)** To hide the entire menu system from view, turn off the on-screen display by pressing **OSD** **Down Arrow**.

Before You Begin ▶ **Use Auto Setup** (Auto)

For a good and efficient first step in perfecting the image, press (Auto). This initiates an automated process in which the projector quickly optimizes critical display parameters such as size, position, pixel tracking, etc., based on the type of incoming source data detected. An *Auto Setup* can save considerable setup time, and you can still modify the adjustments as desired using menu options described below.

Size and Position Menu ▶ In the *Size and Position* menu, you can increase or decrease the size of your image, change its proportion (aspect ratio), move the image to a specific area of the screen, and refine other related parameters. Use *Size and Position* controls to match the image precisely to the screen used at the site.

Size and Position			
1.	Resize Presets	No Resizing	▼
2.	Size	0.729	<input type="text"/>
3.	Vertical Stretch	1,000	<input type="text"/>
4.	Pixel Track	858	<input type="text"/>
5.	Pixel Phase	0	<input type="text"/>
6.	H-Position	360	<input type="text"/>
7.	V-Position	262	<input type="text"/>
8.	Reserved		
9.	Reserved		
0.	Advanced Size and Position		

Refer to "Using Slide bars and Other Controls" (earlier in this section) if you need help using any of the options and controls. Changes made in the *Size and Position* menu are applied immediately and are saved when you exit the menu (press (Exit) or (Menu)).

Resize Presets

NOTE: The same resize presets are available to all HD and HD2 widescreen models. Please note however, the graphics used to describe each preset in this section are of the SXGA+ models only.

Select a *Resize Presets* option to quickly display an image in its native resolution or to automatically resize an image to closely fill the projector’s native resolution or to optimize the width or height of your display.

Resize Presets	
1. Default	= maximize for current source
2. No Resizing	= display in native resolution
3. Full Size	= fill the screen (regardless of source)
4. Full Width	= fill display width & keep aspect ratio
5. Full Height	= fill display height & keep aspect ratio
6. Anamorphic	= retain 16:9 aspect ratio
Custom (not selectable)	= non-preset values for Size, Vertical Stretch, H-Position, V-Position and/or Blanking

Size, Position and *Blanking* parameters will automatically adjust accordingly or, if *Blanking*

is set first, which defines an Active Input Area; *Resize Preset* scaling will occur in this region of interest only. Resizing options are explained in detail below.

WHAT IS THE RESIZING DEFAULT? By default when displaying a new source, your image will utilize as much of the projector’s display area as possible for the type of incoming source data, but with minimal or no changes to aspect ratio. See *Select “Default”* below.

WHEN “CUSTOM” APPEARS: The “Custom” re-size descriptor automatically appears in the *Size and Position* menu when any of the values for *Size, Vertical Stretch, H-Position, V-Position* or *Blanking* do not correspond to those for a preset. This option is not offered in the *Resize Presets* pull-down list.

- Select “**DEFAULT**” for most sources (factory default). The image will be centered and displayed as large as possible *depending on the type of source*.

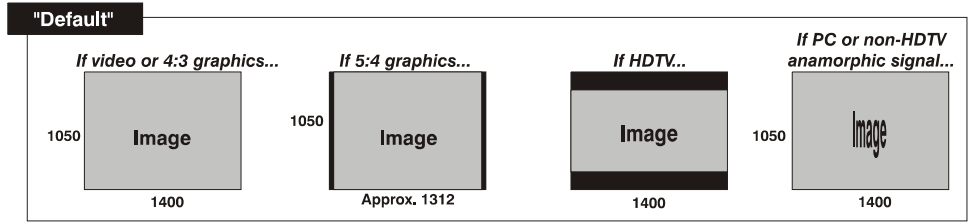

- Select “**NO RESIZING**” to display the image in its native resolution, which may or may not match the projector’s resolution. For example, for a source with a native resolution of 800 x 600, “No Resizing” in an SXGA+ projector will use the central 800 x 600 pixels and have a black border—the black border areas are unused areas. See below.

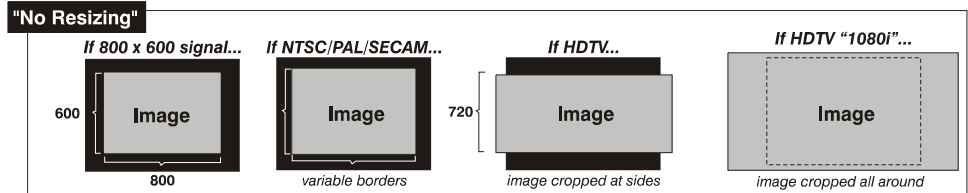

- Select “**FULL SIZE**” to use *all pixels* for displaying the image, regardless of source or original aspect ratio. Incoming source material having a different aspect ratio than the projector will be stretched for display.

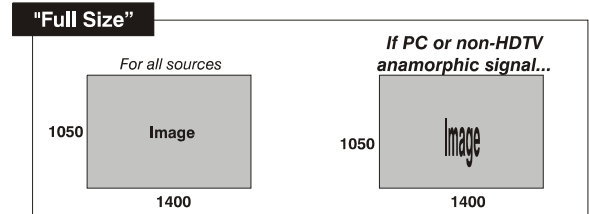

- Select “**FULL WIDTH**” to fill the projector’s display from left-to-right without changing the original aspect ratio of the image. Depending on the source, data at the top and bottom may be discarded (cropped), or the display may have black borders at the top and bottom (called “letterboxed”).

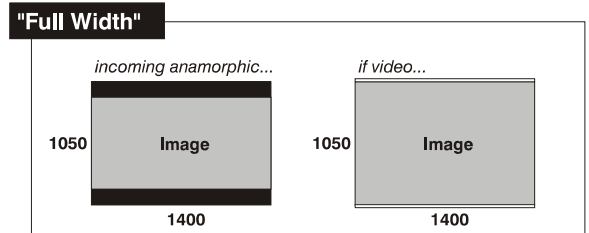

- Select “**FULL HEIGHT**” to fill the display from top-to-bottom. Depending on the source, this may create borders.

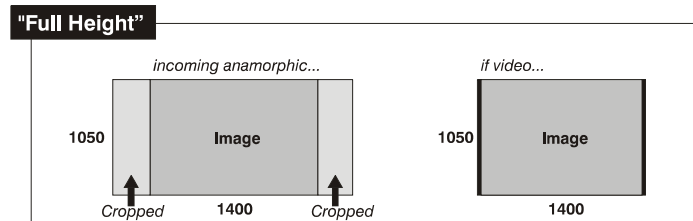

- Select “**ANAMORPHIC**” to display an anamorphic image in its native 16:9 aspect ratio. The image will

fill the screen from side-to-side and be centered between black bars at top and bottom.

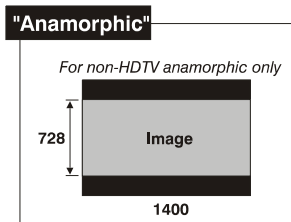

Size

“Size” controls both the image *width* and *height* in tandem, maintaining the current aspect ratio (proportion) of the displayed signal data.

Vertical Stretch

“Vertical Stretch” adjusts the *height* of the image while keeping the width constant. Use “Vertical Stretch” to change the aspect ratio of the display.

Pixel Track

Steady flickering or several soft vertical stripes or bands across the entire image indicates poor pixel tracking. Proper pixel tracking helps ensure that the image quality is consistent across the screen, the aspect ratio is maintained, and that the pixel phase can be optimized (described below). Tracking determines the frequency of the pixel-sampling clock, indicated by the number of incoming pixels per line, so that all pixels generated by a particular source are sampled.

NOTE: *By default, the projector samples at the correct frequency for most sources.*

For best results, use a good test pattern such as a smooth gray consisting of a clear pattern of black and white pixels, or a similar “half on, half off” graphic image, such as the *Windows* shutdown screen. Adjust the slide bar until the vertical stripes broaden to the point where one large stripe fills the image. If the image still exhibits some shimmer or noise, adjust *Pixel Phase* (below).

Pixel Phase

NOTE: *Adjust “Pixel Phase” after “Pixel Tracking”.*

Adjust pixel phase when the image (usually from an RGB source) still shows shimmer or “noise” after pixel tracking is optimized. Pixel phase adjusts the phase of the pixel-sampling clock relative to the incoming signal.

For best results, use a good test pattern such as a smooth gray consisting of a clear pattern of black and white pixels, or a similar “half on, half off” graphic image, such as the *Windows 2000* shutdown screen. Adjust the slide bar until the image stabilizes and each pixel is clearly defined. You may notice that you can stabilize the image at more than one point—i.e., you may find that the image appearance at “11” is identical to the image appearance at “38”, thus you can use either setting.

If some shimmer from a video or HDTV source persists, use the “Filter” control to remove high-frequency noise from the signal.

H-Position

This option moves the image right or left within the area of available pixels.

NOTE: The value shown represents where the approximate center of the image lies in relation to the total number of pixels available horizontally. This varies widely according to the signal—watches the image while adjusting.

V-Position

This option moves the image up or down within the area of available pixels.

NOTE: The value shown represents where the approximate center of the image lies in relation to the total number of pixels available vertically. This varies widely according to the signal—watches the image while adjusting.

Advanced Size and Position — SUBMENU

This submenu consists of the following options:

ACTIVE INPUT WINDOW: This read-only value indicates the current size (i.e., area) of your displayed data or “region of interest” as defined by the blanking controls. By default, the projector automatically determines what portion of its full resolution to use, and pixels in the surrounding borders are turned off. You can also specify a specific active input window size by adjusting one or more “Blank” settings. For example, if you have blanked (cropped) 100 pixels from both the left and right edges of an incoming source of 1400 x 1050, the remaining active input window will be reduced to 1200 x 1050. When using SD or HD or a decoded video source at **INPUT 3** or **INPUT 4**, the default blanking of “0” defines an active input window of 720 x 483.

Advanced Size & Position			
Active Input Window		720x483	
1.	Top Blank	0	<input type="text"/>
2.	Bottom Blank	0	<input type="text"/>
3.	Left Blank	0	<input type="text"/>
4.	Right Blank	0	<input type="text"/>
5.Plug & Display <EDID>			Native Resolution 60Hz ▼

BLANKING (TOP, BOTTOM, LEFT, and RIGHT): Crop the image as desired so that unwanted edges are removed from the display (changed to black—see right). Blanking defines the size of the *Active Input Window*, or area of interest. Range of adjustment depends on the source resolution and other factors. After adjustment of blanking it may be necessary to perform a source switch.

NOTE: Blanking a PIP image resembles zoom (see Figure 3.6). For example, left Blanking zooms the right side of the PIP image; Right Blanking zooms the left side. There are no black bars.

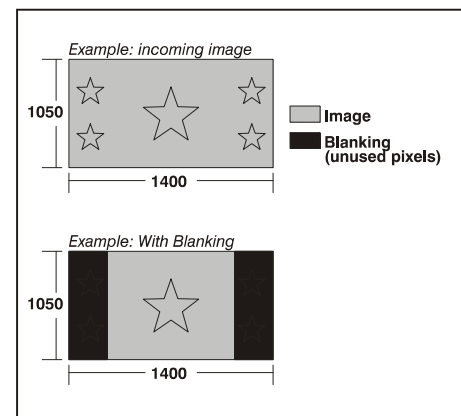

Blanking of a Primary Image

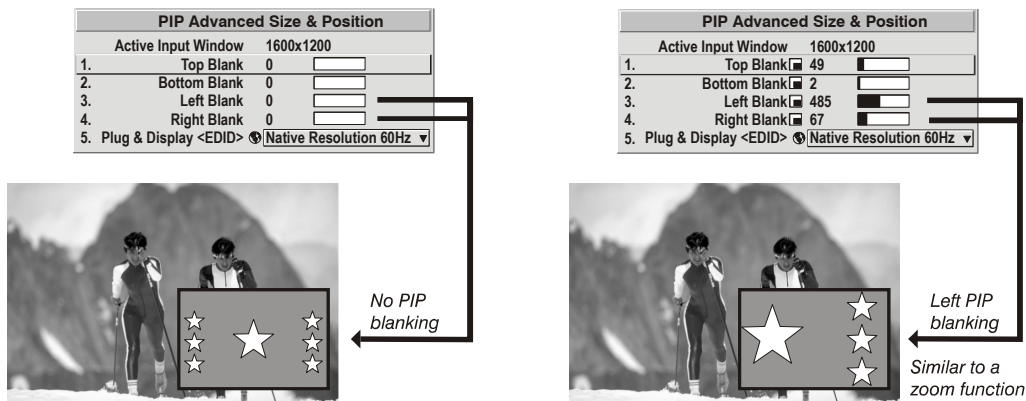

Figure 3.6. Blanking of a PIP Image

PLUG & DISPLAY (EDID): By default, a *Plug & Play* <EDID> source outputs a signal according to the EDID information provided by the projector. To override this information and display in a different format (for example, if your *Plug & Play* [EDID] device does not support the projector’s resolution and/or frequency), select the desired *Plug & Play* <EDID> resolution from the list.

Any daisy-chained projectors will also display according to the chosen *Plug & Play* <EDID> format.

EDID = Extended Display Identification Data standard.

- ▶ 1. Native Resolution 60 Hz
- 2. 1400 x 1050 60 Hz
- 3. 720p (1280x720 60Hz)
- 4. DC2K (2048x720 60Hz)
- 5. 1024x768x116Hz 3D
- 6. 1280x1024x110Hz 3D
- 7. 1400x1050x102Hz 3D
- 8. 1080p 60Hz / 1080i 60Hz
- 9. 1080p 50Hz / 1080i 50Hz
- 0. 1080p 24Hz / 1080i 30Hz

Image Settings Menu ▶ Use options in the *Image Settings* menu to alter your main image without affecting its size or position. Changes made to the *Image Settings* menu are applied immediately and are saved when you exit the menu (press **Exit** or **Menu**). Options not available for the projector model or source are disabled and appear dim (gray).

Image Settings			
1.	Contrast	50.0	<input type="text"/>
2.	Brightness	50.0	<input type="text"/>
3.	Gamma	2.2	<input type="text"/>
4.	Filter	Off	<input type="text"/>
5.	Detail	0	<input type="text"/>
6.	Noise Reduction	0	<input type="text"/>
7.	Color Space	YPbPr	<input type="text"/>
8.	Video Options		
9.	Input Levels		
0.	Advanced Image Settings		

Contrast

(SHORT CUT: Press **Contrast** and adjust the slide bar.)

“Contrast” increases or decreases the perceived difference between light and dark areas of your image (0-100). For best results, keep close to 50. If contrast is set too high, the light parts of the image lose detail and clarity. If the contrast is set too low, the light areas will not be as bright as they could be and the overall image will be dim. For best results, start with a low value and increase so that whites remain bright but are not distorted or tinted, and that light areas do not become white (i.e., are “crushed”).

NOTE: *If the environment lighting changes, an adjustment of Gamma is recommended (see below).*

Brightness

(**SHORT CUT:** Press  and adjust the slide bar.)

“Brightness” increases or decreases the amount of black in the image (0-100). For best results, keep close to 50. Start with a high value and decrease so that dark areas do not become black (i.e., are “crushed”). Conversely, high brightness changes black to dark gray, causing washed-out images.

Gamma

(**SHORT CUT:** Press  and adjust the slide bar.)

“Gamma” is a global setting that determines what gray shades are displayed between minimum input (black) and maximum input (white) for all signals. A good gamma setting helps to optimize blacks and whites while ensuring smooth transitions for the “in-between” values utilized in other colors. Thus, unlike “Brightness” and “Contrast” controls, the overall tone of your images can be lightened or darkened without changing the extremes, and all images will be more vibrant while still showing good detail in dark areas.

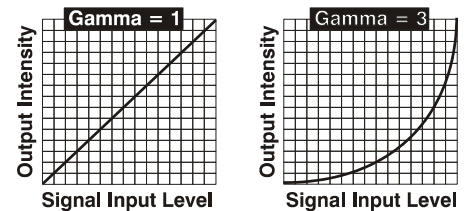

Gamma is used to fine-tune the gamma table currently in use, ranging from 1 – 3 (2.2 = default). If excess ambient light washes out the image and it becomes difficult or impossible to see details in dark areas, lower the gamma setting to compensate. This will improve contrast while maintaining good details for blacks. Conversely, if the image is washed out and unnatural, with excessive detail in black areas, increase the setting. In high ambient light conditions, lower gamma may produce better results than higher gamma. Gamma of 2.2 (default) indicates the gamma table has not been adjusted. For more information, refer to *Advanced Image Settings* submenu, *Gamma Table*. Again, good gamma improves contrast while maintaining good details for blacks.

Filter

The proper filter setting is automatically set for virtually all signals, and rarely needs to be changed. It applies a low pass filter for noise reduction in the incoming input signal, particularly for HDTV or SDTV. Applied in the analog domain before sampling, this filtering removes high frequencies and thus reduces pixel phase noise (note this also reduces signal bandwidth). Override only if standard pixel tracking and phase adjustments do not adequately clear up a “noisy” video signal, or if a graphics signal appears overly “soft”. Both instances indicate that “Filter” may be set to the wrong option.

- ▶ 1. Off
- 2. RGB
- 3. HDTV
- 4. EDTV
- 5. SDTV

Detail

“Detail” adjusts the sharpness of a video image so that edges remain clearly defined. It can be particularly useful if a significant “Noise Reduction” adjustment has caused the image to appear too soft. Adjust until the display is as sharp as desired, keeping in mind that because “Detail” adds some high frequencies back into the image, it can also re-introduce a certain degree of noise.

Noise Reduction

“Noise Reduction” is similar to the “Filter” control, but operates in the post-sampling digital domain with a more subtle effect. Higher settings are most useful for clearing up noisy RGB images such as those from a PC. Adjust as desired, keeping in mind that reducing noise (which reduces high frequencies) may also soften the image.

Color Space

“Color Space” determines how the color components of an analog input signal are decoded for accurate color in the display. Selecting a color space option is useful only for analog signals and certain digital sources connected to **INPUT 1**, **INPUT 2**, **INPUT 5** or **INPUT 6**. Although color space for these analog signals is automatically determined by the projector, in some circumstances you may wish to override this and manually set a specific color space.

- ▶ 1. RGB
- 2. YPbPr (Video)
- 3. YPbPr (HDTV)

NOTE: For many digital signals or for signals connected to **INPUT 3** or **INPUT 4**, the color space function is entirely automatic and the pull-down list disabled.

The current color space appears in the *Image Settings* menu. Press to select a different option:

- Select **RGB** unless you are using component video at **INPUT 1, 2, 5** or **6**.
- Select **YPbPr (Video)** with a standard definition televised signal (SDTV).
- Select **YPbPr (HDTV)** with a high definition televised signal (HDTV).

NOTE: When certain RGB signals are first connected, the projector may not initially recognize them as RGB and will incorrectly decode their color information as YPbPr (video). These signals can include:

- RGB signals in NTSC, PAL, SECAM frequency ranges.
- Scan-doubled sync-on-green.
- Scan-quadrupled sync-on-green.

For these signals, change the Color Space to RGB, and then define a new channel for future use.

Video Options — SUBMENU

This submenu is used with video sources only (**INPUTS 3** or **4**).

Video Options	
1. Enable Decoder AGC	<input checked="" type="checkbox"/>
2. Video Standard	
3. Input Video Black	
4. Color	50.0
5. Tint	50.0
6. Decoder Luma Delay	35

ENABLE DECODER AGC: Automatic Gain Control (AGC) affects decoded video images only. Enter a checkmark (default) in most instances—this activates the decoder’s AGC circuit to ensure properly bright images. Delete the checkmark if a decoded video image exhibits strange color artifacts such as stripes in highly saturated colors, indicating an incompatibility between this source and the AGC.

VIDEO STANDARD: For all but the more unusual video standards available in the world, the projector automatically detects the incoming horizontal and vertical frequencies and sets the projector’s processing of this signal to the corresponding standard. The current video standard name appears in the *Video Options* submenu, and includes an “A” if it has been auto-detected. Press (←) to view or select a different video standard from those available to the projector—any that are disabled have frequency characteristics that differ from those of the incoming signal. Selecting a specific standard forces the projector to process the signal according to this standard.

- 1. Auto
- 2. NTSC
- ▶ 3. NTSC 4.43
- 4. PAL
- 5. PAL-M
- 6. PAN-NC
- 7. PAL-60
- 8. SECAM

NOTE: *Best results are obtained with defined channels. Otherwise, switching from one video source to another can sometimes cause slight disturbances in the display, indicating that the Auto function is struggling. Recover by briefly selecting a different video standard, then going back.*

Table 3.3. Regions and Video Standards: Summary

Standard	Where Used (SUBJECT-TO-CHANGE)
NTSC	N. America and Japan
NTSC 4.43	A tape-only standard for partially-translated hybrid signals
PAL	Most of Europe, China, Australia, some of S. America, some of Africa
PAL-M	Brazil
PAL-NC	Argentina, Chile, other Latin American countries
PAL 60	
SECAM	France, Eastern Europe, most of Africa

NOTE: *Generally, use “Auto” for all instances EXCEPT: 1) a poor quality input signal or 2) a black-and-white video signal. In order to detect and display such signals, select the relevant standard from the list.*

INPUT VIDEO BLACK: This control compensates for incoming elevated black levels present in certain video signals, and ensures that blacks in the display are neither crushed (i.e., where dark grays appear black) nor excessively elevated (i.e., where blacks appear dark gray). By default, the projector automatically determines the best setting according to the type of incoming video signal:

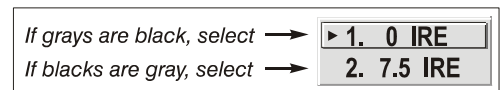

- **0 IRE** – Used for DVD output with “enhanced black”, SECAM, most PAL standards, and Japanese NTSC.
- **7.5 IRE** – Used for most NTSC video signals.

For some types of video, you can override the setting. The control is disabled for other types of video (and all graphics sources). Generally, if black appears crushed when brightness = 50, choose “0 IRE”. If black appears excessively elevated, use “7.5 IRE”.

COLOR: This slide bar adjusts the color saturation level, i.e., the *amount* of color in a video image. Lower settings produce less saturated colors — for example a setting of “0” produces a black and white image. If the color level is too high, colors will be overpowering and unrealistic.

TINT: This slide bar adjusts the red/green color hue for true color reproduction of video and HDTV signals connected to Input 3 or 4. For best results, adjust tint while displaying an external test pattern—otherwise, it is recommended that tint remain at its default setting.

DECODER LUMA DELAY: This control affects any incoming composite or S-video signal, delaying the luma signal (intensity) in relation to the chroma (color). In the image, increasing the luma delay will move luma (seen as a shadow where colors overlap) to the right slightly, with colors remaining in place. Decreasing this delay will move the shadow slightly to the left. If necessary for your current source, adjust so that no shadows occur with adjacent colors.

Input Levels — SUBMENU

NOTES: **1)** Because the projector automatically optimizes input levels for all but the most unusual of sources, it is recommended that only experienced users use the **Input Levels** submenu. **2)** Before beginning, check that overall contrast and brightness settings are near 50 **and** that color temperature is properly set up on an internal grayscale test pattern. **3)** There must be at least two consecutive white pixels present in the image for proper “Auto Input Level” function. Leave this control **off** after use.

Good RGB or input levels—that is, the *drives* and *black levels* for each of the three colors, red, green and blue—ensure that images from analog sources other than decoded video have maximum contrast without crushing black or white. By default (and in an “Auto Setup”), the projector automatically determines the best input levels by monitoring image content and adjusting the controls appropriately—further adjustment is typically not required to obtain proper blacks or whites.

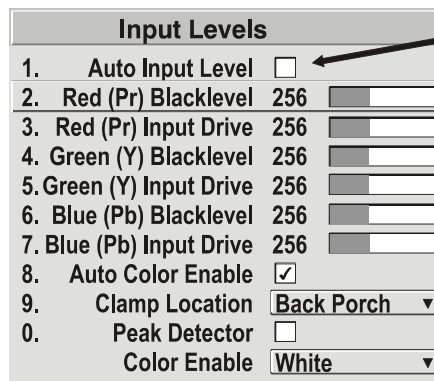

Turn OFF before leaving menu.

Levels adjust automatically and correctly.

NOTE: Image must have at least 6-12 adjacent white pixels for “auto” to work.



NOTE: This automatic adjustment requires at least 6-12 consecutive white pixels in the image. Without these pixels, input levels may produce skewed colors, particularly in non-video images.

However, for a very unusual source exhibiting one or more overly high black levels (typically caused by a noisy source causing black level spikes), an experienced user may prefer to use the *Input Levels* menu (shown above). These adjustments, which together serve as a calibration process compensating for differences in sources and cabling, enable an experienced user to perfect the source image input levels and eliminate the “overshoot” and “undershoot”. Note that *Input Levels* are of limited use with digital signals, but do offer some ability to tweak poorly mastered source materials.

NOTES: **1)** Input levels apply for the current source only, but for any color temperature used. **2)** Assuming that color temperature has been set up based on the internal test patterns, you can then set up input levels for a given source so that it matches the color temperature of the internal test patterns.

AUTO INPUT LEVEL – Temporarily enter a checkmark *only* if you are an experienced user and you have an unusual source that you feel needs further color temperature and/or input level adjustment. This compensates for incoming out-of-range drives (white) and black levels (black) that would cause “crushing” of light and dark colors in the image. After entering a checkmark, wait for the six slide bar values to stabilize, and then delete the checkmark and exit. The Auto Input Level is automatically turned off upon exit from the Input levels Menu.

BLACK LEVELS AND DRIVES - To check your image levels and adjust these controls:

1. Ensure overall “Contrast” and “Brightness” settings are both set to near 50.
NOTE: Not required for “Auto” adjustment.
 -  = 50 (approx.)
 -  = 50 (approx.)
2. Check the color temperature setup using an internal grayscale test pattern, making sure to obtain a neutral grayscale.
NOTE: *Not required for “Auto” adjustment.*
3. Confirm that you are using an analog or digital source not connected to INPUT 3 or INPUT 4. Input Levels are not applicable for sources going through the decoder. A grayscale is recommended.
4. If the blacks and/or whites appear OK, input levels do not need adjustment. If black levels are too high (and/or whites are too low, which is rare), you likely have a noisy source that is producing skewed input levels. Continue with Step 5.
5. Temporarily enable “Auto” in the Input Levels submenu. Wait for all six values to stabilize. Alternatively, do not use “Auto”—reduce black levels manually instead. Judge by eye and change one or more of the six levels as necessary to obtain proper blacks and whites. You may want to see only a certain color while adjusting—use the “Color Enable” option (described below).
6. Delete the “Auto” checkmark and leave the Input Levels menu.

IMPORTANT: Do not use Input Levels to adjust color temperature. This will distort Contrast and Brightness functions as well as color temperature.

AUTO COLOR ENABLE – When a checkmark is present, selecting a specific black level or drive to adjust will automatically enable the corresponding color in the display. Delete the checkmark to see all colors, or to enable a different specific color through the Color Enable Control.

CLAMP LOCATION – This option (formerly known as *sync tip clamping*) can brighten the image produced from certain high-resolution high-frequency graphic sources. The projector automatically selects the best clamp location for almost all sources. Use the normal *Back Porch* location if the image is either sufficiently bright or overly bright. Select *Sync Tip* if the image appears unusually dim, if there are horizontal streaks across the image, or if there is significant color drift. This moves the clamping pulse from the normal back porch location (which is likely too short) to the tip of the horizontal sync pulse. *Tri Level* is typically needed for an HDTV source.

- | |
|-----------------|
| ▶ 1. Back Porch |
| 2. Sync Tip |
| 3. Tri Level |

COLOR ENABLE –Select which color or colors you want to see in the display, useful while working with color temperature white levels or input levels.

NOTES: **1)** *Input levels apply for the current source only, but for any color temperature used.* **2)** *Assuming that color temperature has been set up based on the internal test patterns, you can then set up input levels for a given source so that it matches the color temperature of the internal test patterns.*

PEAK DETECTOR – The Peak Detector is a tool to assist with defining individual input levels, enabling you to accurately set the Input Levels for any particular source with the appropriate image. Enabling the Peak Detector activates a special operating mode for detecting **only** pixels that are considered black or white—all other levels are displayed as a mid-level gray. When used with a smooth grayscale pattern in which black and white are known to be at opposite edges of the image, you can watch these isolated areas while adjusting individual black levels and input drives until both black and white edges are **just** visible and distinguished from neighboring pixels. Images from this source will then display correct blacks and whites without crushing.

See Figure 3.7. **Adjusting Input Levels Using the Peak Detector:**

1. Display a 16 level grayscale test pattern from the desired external source, and enter a checkmark in the Peak Detector checkbox.
NOTE: *The “Peak Detector” will initially render the grayscale as a uniform gray field before adjustment or extreme crushing.*
2. Display one primary color.
NOTE: *Selecting Auto Color Enable ensures the correct color is displayed for each setting.*
3. For the current color, adjust its corresponding “Black level” slide bar **just** until a single band of black appears at one edge of the screen. This band represents the first band of the grayscale pattern, which should be 100% black. Do not adjust too far.
4. With the same color still active, adjust its corresponding “Input Drive” slide bar **just** until a single band of color appears at the opposite edge of the screen. This band represents the last band of the grayscale pattern, which should be 100% white (or the current color, if a certain color is enabled). Do not adjust too far.
5. It may be advantageous to go back and check the black band—adjust the black level slide bar if necessary.
NOTE: *Readjusting the black levels affects the gain at this point; only readjust when absolutely necessary.*
6. Repeat Steps 3-5 with the other two remaining primary colors. When each primary color shows **one** optimized black band and white (or colored) band, the input levels for this source are correctly set. Upon exiting the *Input Levels* menu, the Peak Detector checkbox will clear.

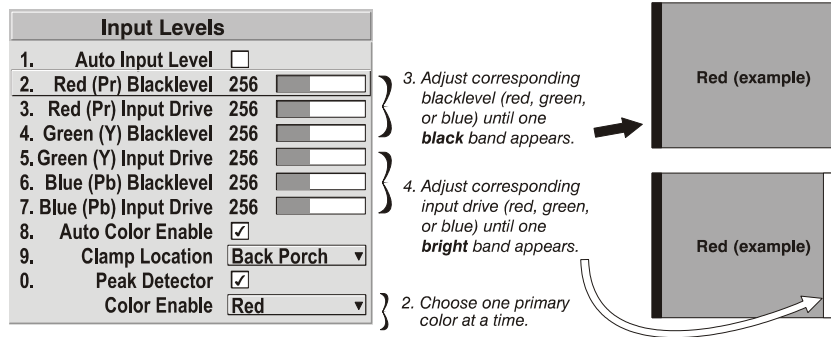
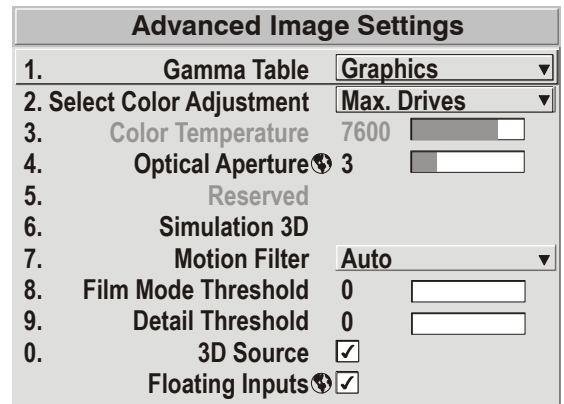

Figure 3.7. Adjusting Input Levels Using the Peak Detector (RED EXAMPLE SHOWN)

Advanced Image Settings — SUBMENU

Use the *Advanced Image Settings* submenu to make the adjustments necessary for lesser-used but more specialized applications on your projector.

NOTE: 3D Source option is only available for Mirage HD.



GAMMA TABLE: This control applies a default *video*, *graphics* or *simple* gamma table or “curve” to your images, controlling the intensity of mid-level colors and producing maximum contrast, brightness and color performance. As shown at right, the graphics curve is a modified power curve that will show more detail in darker areas of the projected content while the video curve has a linear segment near black to compensate for increased black levels typical of video signals. A simple gamma curve is a true power curve that does not alter the contrast or the intensity of mid-level colors. Although the projector automatically applies either the graphics or video curve according to what type of incoming signal is detected, in some cases you may wish to override this default and use *graphics* gamma for a video source or *video* gamma for a graphics source. Alternatively, if neither default is ideal, you may prefer to apply the simple (non-optimized) gamma curve or a user-defined custom gamma curve that has been created externally, named, and downloaded to the projector (requires separate PC-based *Arbitrary Gamma* and *KoRE Librarian* software applications). If any of these special user curves have been installed, their names will appear in the Gamma Table pull-down list.

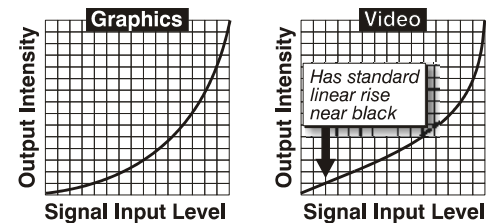

Keep in mind that any *Gamma Table* choice sets the related *Gamma* value (shown in the *Image Settings* menu) to a 2.2 default, where it can be fine-tuned as desired. Different values (1-3) here indicate that the original gamma table has been adjusted with either the *Gamma* slide bar or direct key.

NOTES: 1) *If no user curves have been defined and downloaded to projector memory, only the 2.2 default gamma curve is available here – adjust as desired using gamma in the main Image Settings menu. 2)* *Some graphic material will look best with the video setting while some video material is best with the graphic setting.*

SELECT COLOR ADJUSTMENT: In “Select Color Adjustment”, choose an overall color palette for all images. The “Max Drives” factory default simply drives all three colors at their maximum level so that they are fully on and cannot be changed. The two other pre-defined color adjustment choices—*SD Video* and *HD Video*—apply a color gamut optimized for video sources (standard or high-definition). Alternatively, you can specify a color temperature. This enables the adjacent Color Temperature slide bar and applies its current setting (default = 6500K). If none of the pre-defined “Select Color Adjustment” options or color temperatures suits your application, select one of four color gamuts previously defined by a user (User 1, 2, 3, 4). A “User” option applies a customized color performance in which the user has precisely set the hue and intensity of each color component in the *Color Adjustment by X/Y* or *Color Saturation* submenus. It is most often needed with multiple-projector applications. Select the color adjustment producing the best color accuracy for your application and installation.

- | |
|----------------------|
| 1. Max. Drives |
| 2. Color Temperature |
| ▶ 3. SD Video |
| 4. HD Video |
| 5. User 1 |
| 6. User 2 |
| 7. User 3 |
| 8. User 4 |

To configure a “User” color adjustment (gamut), use either the *Color Adjustment by X/Y* or *Color Saturation* submenu.

NOTES: 1) *“Color Temperature” defaults to 6500K until changed. All four “User” options default to SD Video unless the user has redefined them. 2)* *Factory-defined color primaries, which ensure consistent color gamut from projector-to-projector, can be calibrated in the Service menu only. If you suspect alteration, the factory settings can be recovered with selection of “Reset to Factory Defaults?” in the Color Primary Settings submenu within the Service menu (password-protected).*

COLOR TEMPERATURE — Adjust to apply a specific and accurate color temperature to all displays. Color temperatures are expressed in degrees Kelvin (3200-9300K), and utilize different combinations of the projector’s original native color primaries to produce a “coloration” or cast (reddish or bluish) in images—the lower the temperature, the more reddish the cast; the higher the temperature, the more bluish the cast. Note that the slide bar is enabled only if you have a source connected and have selected “Color Temperature” in the adjacent “Select Color Adjustment” pull-down list in the *Advanced Image Settings* menu.

OPTICAL APERTURE - The optical aperture inside the projector controls the diameter of the light beam passing through the system. With a fully open aperture (slide bar default of “0”), the maximum amount of light passes through for maximum brightness in your images. Increase the slide bar setting to reduce the aperture diameter and maximize contrast ratio instead. Performance of aperture depends on the lens in use.

NOTE: *Optical Aperture also appears in the lamp menu.*

Aperture Manual Adjustment - A variable position manual aperture is present on the 1.2:1 and 1.1:1 lens. It may be used together with the internal electronic aperture to increase the contrast ratio; noting a slight decrease in brightness when it is used. It is recommended for highest brightness operation, under normal conditions, the manual aperture is to be left open. See Aperture Manual Adjustment below for aperture open/close and lock and unlock dial positions. **NOTE:** *The lock/unlock dial position allows you to open the aperture at a desired position and lock it in place.*

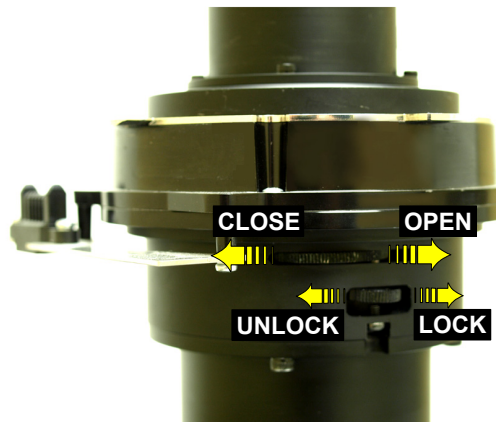

Aperture Manual Adjustment

RESERVED - No function.

Mirage S+ Series — Simulation 3D — SUBMENU OF ADVANCED IMAGE SETTINGS

Use the options in the *Simulation 3D* menu to make the timing adjustments necessary for realistic simulation and 3D images.

NOTE: *For complete 3D application notes, refer to the separate Using 3D in Mirage manual provided with the Mirage projector.*

Simulation 3D	
	Frame Delay Monitor 1047
1.	Frame Delay 1000 <input type="text"/>
2.	Dark Interval 128 <input type="text"/>
3.	3D Stereo Sync Locking Output ▼
4.	3D Stereo Sync Select Input A ▼
5.	3D Stereo Sync Delay 1000 <input type="text"/>
6.	Frame Lock Enable Locked ▼
7.	Reserved

Mirage S+ Models

FRAME DELAY MONITOR —For best results, the value should remain fairly constant, indicating that timing of input and output frames is locked; the Frame Delay Monitor value should stay within 5-10 lines or so of the Frame Delay setting. If a frame is lost or “dropped”, this value will cycle to maximum and jump to minimum and then repeat, indicating that the frame input is no longer equal to the output. If the signal is not locked, the values will change erratically; you can adjust the Frame delay to attempt a correction.

NOTE: *See separate Using 3D in Mirage manual provided for more information.*

FRAME DELAY — Set the number of lines delayed between the input signal and its appearance on screen, keeping in mind that projector processing always *adds one frame of delay* to the frame delay setting. For applications such as simulation, where the feeling of “real time” image response is a priority, a minimum setting is usually preferable. For projectors capable of 3D (stereographic) applications where alternating left-right frames must be synchronized with the corresponding L/R shutters in 3D glasses, a total frame delay setting of two (or multiple of two) may be more useful. If set too high or low, frame locking will not be possible—most sources require approximately 50 lines of delay to ensure frame locking.

NOTE: See separate *Using 3D in Mirage* manual provided for more information.

DARK INTERVAL — Adjust Dark Interval to artificially increase the amount of dark time between displayed frames for stereographic 3D images. Higher settings provide more time for shutters in 3D glasses to open/close, ensuring that each eye sees the full display intended for it. Symptoms of cross talk and/or color artifacts can indicate need for adjustment. The Dark Interval range of adjustment depends on the vertical frequency of your source—the higher the frequency, the smaller the range.

NOTE: See separate *Using 3D in Mirage* manual provided for more information.

3D STEREO SYNC LOCKING — This option defines 1) whether or not the incoming stereographic 3D signal locks to the vertical sync output so that signals are synchronized, and 2) whether or not the 3D frames must be inverted, i.e. swapped left-with-right. The correct setting ensures that the projector’s 3D display of left/right frames is synchronized with the rest of the 3D system components so that the intended eye sees the left/right image data. Select the option corresponding to your 3D source connections and timing, and use only if the *Mirage 3D Stereo Sync Cable* is connected between the projector’s GPIO port and a server. Keep this adjustment OFF (default) when you are not using the *Mirage 3D Stereo Sync Cable*.

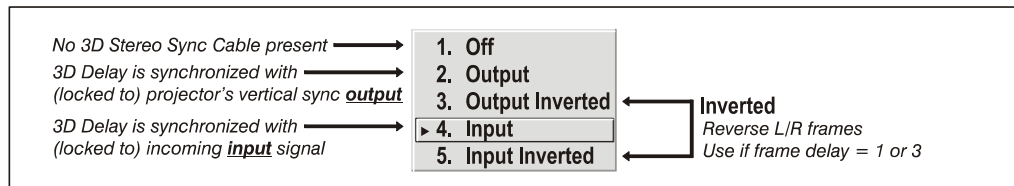

With your sync cable and, if desired, emitter connected as described in the *Using 3D in Mirage* manual, select the option suited to your 3D configuration (see above). If Frame Delay is two (or 0), do not invert; if frame delay is one or three, invert. Generally, an “Unlocked” setting is synchronized with the incoming L/R signal rather than the vertical sync output, and may be needed only with multi-projector installations in which the vertical sync outputs vary.

NOTE: See separate *Using 3D in Mirage* manual provided for more information.

3D STEREO SYNC SELECT

— Define which of the *Mirage 3D Stereo Sync Cable*’s input connectors is routed from your server. Use only if the cable is present.

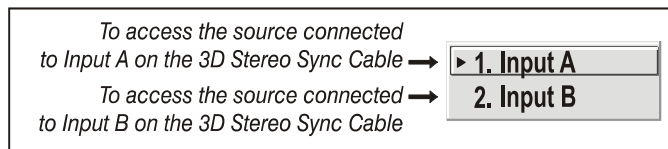

3D STEREO SYNC DELAY — Set when the L/R frames begin, defining the best reference point for synchronizing the display with your glasses. Proper adjustment of this delay should eliminate cross talk and odd colors caused by timing differences between the glasses and the projected display. Use this slide bar only if the *Mirage 3D Stereo Sync Cable* is connected between the projector’s GPIO port and a server. Slide bar values indicate the number of lines that are delayed.

FRAME LOCK ENABLE — This option allows the projector to control the output frame timing based on the input signal. The *locked* option forces (if possible) the output image to be phase locked to the input frames. *Rate Matched* means that the output runs at close to the input frequency but isn’t locked to it so the output will drift in phase relative to the output. Free Run forces the output to run at a 60Hz frame rate.

- ▶ 1. Locked
- 2. Rate Matched
- 3. Free Run

NOTE: 1) See separate *Using 3D in Mirage* manual provided for additional information.

Mirage HD & WU Series — Simulation 3D — SUBMENU OF ADVANCED IMAGE SETTINGS

Use the options in the *Simulation 3D* menu to make the timing adjustments necessary for realistic simulation and 3D images.

NOTE: For complete 3D application notes, refer to the separate *Using 3D in Mirage* manual provided with the *Mirage* projector.

Simulation 3D	
Frame Delay Monitor	1047
1. Frame Delay	1000 <input type="text"/>
2. Dark Interval	2500 <input type="text"/>
3. 3D Sync Input	Input A ▼
4. 3D Sync Output	To Emitter ▼
5. 3D Stereo Sync Delay	592 <input type="text"/>
6. Frame Lock Enable	Locked ▼
7. 3D Source	<input checked="" type="checkbox"/>

Mirage HD Models

FRAME DELAY MONITOR —For best results, the value should remain fairly constant, indicating that timing of input and output frames is locked; the Frame Delay Monitor value should stay within 5-10 lines or so of the Frame Delay setting. If a frame is lost or “dropped”, this value will cycle to maximum and jump to minimum and then repeat, indicating that the frame input is no longer equal to the output. If the signal is not locked, the values will change erratically; you can adjust the Frame delay to attempt a correction.

NOTE: See separate *Using 3D in Mirage* manual provided for more information.

FRAME DELAY — Set the number of lines delayed between the input signal and its appearance on screen, keeping in mind that projector processing always *adds one frame of delay* to the frame delay setting. For applications such as simulation, where the feeling of “real time” image response is a priority, a minimum setting is usually preferable. For projectors capable of 3D (stereographic) applications where alternating left-right frames must be synchronized with the corresponding L/R shutters in 3D glasses, a total frame delay setting of two (or multiple of two) may be more useful. If set too high or low, frame locking will not be possible—most sources require approximately 50 lines of delay to ensure frame locking.

NOTE: See separate *Using 3D in Mirage* manual provided for more information.

DARK INTERVAL — Adjust Dark Interval to artificially increase the amount of dark time between displayed frames for stereographic 3D images. Higher settings provide more time for shutters in 3D glasses to open/close, ensuring that each eye sees the full display intended for it. Symptoms of cross talk and/or color artifacts can indicate need for adjustment. The Dark Interval range of adjustment depends on the vertical frequency of your source—the higher the frequency, the smaller the range.

NOTE: See separate *Using 3D in Mirage* manual provided for more information.

3D SYNC OUTPUT — This option defines 1) whether or not the sync will be frame doubled on the output, and 2) whether or not the 3D frames must be inverted, i.e. swapped left-with-right. The correct setting ensures that the projector’s 3D display of left/right frames is synchronized with the rest of the 3D system components so that the intended eye sees the left/right image data. Select the option corresponding to your 3D source connections and timing, and use only if the *Mirage 3D Stereo Sync Cable* is connected between the projector’s GPIO port and a server. Only the last projector in the chain that is connected to the emitter will choose one of the emitter choices; all other projectors will choose ‘To Next Input’. Choose OFF when you are not using the *Mirage 3D Stereo Sync Cable*.

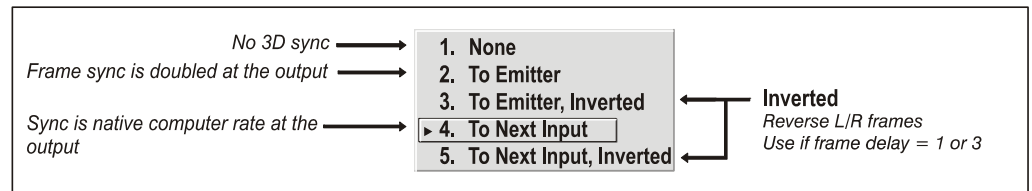

With your sync cable and, if desired, emitter connected as described in the *Using 3D in Mirage manual*, select the option suited to your 3D configuration (see above). If Frame Delay is two (or 0), do not invert; if frame delay is one or three, invert. Generally, an “Unlocked” setting is synchronized with the incoming L/R signal rather than the vertical sync output, and may be needed only with multi-projector installations in which the vertical sync outputs vary.

NOTE: See separate *Using 3D in Mirage* manual provided for more information.

3D SYNC INPUT — Define which of the *Mirage 3D Stereo Sync Cable*’s input connectors is routed from your server. Use only if the cable is present. Only the first projector, possibly connected to external sync, will choose any of these selections. Every other projector will be getting sync from the previous projector on Input A or Input B.

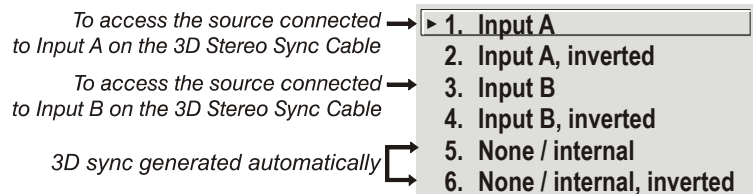

3D STEREO SYNC DELAY — This value is set when the L/R frames begin and by default, is automatically calculated based on signal timing; it defines the best reference point for synchronizing the display with your glasses. Proper adjustment of this delay should eliminate cross talk and odd colors caused by timing differences between the glasses and the projected display. Slide bar values indicate the number of lines that are delayed. **NOTE:** See Help menu to view the formula used to calculate this value.

FRAME LOCK ENABLE — This option allows the projector to control the output frame timing based on the input signal. The *locked* option forces (if possible) the output image to be phase locked to the input frames. *Rate Matched* means that the output runs at close to the input frequency but isn't locked to it so the output will drift in phase relative to the output. Free Run forces the output to run at a 60Hz frame rate.

NOTE: 1) See separate *Using 3D in Mirage* manual provided for additional information.

3D SOURCE — When using a Mirage projector with HD resolution, a checkbox option called **3D Source** will be added to the bottom of the *Simulation 3D* menu. This checkbox must be set by the user for all new 3D sources, and cleared for all new non-3D sources (default setting is checked). Once set, this value will be maintained for that source for all future uses. This option is also available under the *Advanced Image Settings* menu.

Simulation 3D — MATRIX MODELS ONLY — SUBMENU OF ADVANCED IMAGE SETTINGS

Use the options in the *Simulation 3D* menu to make the timing adjustments necessary for realistic simulation and 3D images.

NOTES: 1) Available in Matrix projectors only.

FRAME DELAY MONITOR —For best results, the value should remain fairly constant, indicating that timing of input and output frames is locked; the Frame Delay Monitor value should stay within 5-10 lines or so of the Frame Delay setting. If a frame is lost or “dropped”, this value will cycle to maximum and jump to minimum and then repeat, indicating that the frame input is no longer equal to the output. If the signal is not locked, the values will change erratically; you can adjust the Frame delay to attempt a correction.

Simulation 3D			
	Frame Delay Monitor	1050	
1.	Frame Delay	1050	<input type="text"/>
2.	Accuframe	0	<input type="text"/>
3.	Reserved		
4.	Reserved		
5.	Reserved		<input type="text"/>
6.	Frame Lock Enable	Locked	<input type="text"/>
7.	Reserved		
8.	Warp Latency	0	<input type="text"/>

All Matrix Models

FRAME DELAY — Set the number of lines delayed between the input signal and its appearance on screen, keeping in mind that projector processing always *adds one frame of delay* to the frame delay setting. For applications such as simulation, where the feeling of “real time” image response is a priority, a minimum setting is usually preferable. For projectors capable of 3D (stereographic) applications where alternating left-right frames must be synchronized with the corresponding L/R shutters in 3D glasses, a total frame delay setting of two (or multiple of two) may be more useful. If set too high or low, frame locking will not be possible—most sources require approximately 50 lines of delay to ensure frame locking.

ACCUFRAME – Increasing the AccuFrame value will reduce the artifacts related to fast motion in simulation content. Symptoms of blurry objects or loss of apparent detail may indicate a need for this value to be adjusted.

NOTE: *If increasing AccuFrame does not improve image quality, reduce the value to 0. Increasing AccuFrame may increase ‘flicker’ of the display and may reduce overall brightness.*

FRAME LOCK ENABLE — This option allows the projector to control the output frame timing based on the input signal. The *locked* option forces (if possible) the output image to be phase locked to the input frames. *Rate Matched* means that the output runs at close to the input frequency but isn’t locked to it so the output will drift in phase relative to the output. Free Run forces the output to run at a 60Hz frame rate.

RESERVED — No function.

WARP LATENCY — Requires optional *TWIST* module. See *Christie TWIST User Manual* provided with the module.

Advanced Image Settings continued — SUBMENU

MOTION FILTER — This control is most useful for smoothing out moving images from interlaced sources. In most cases the proper Motion Filter setting is automatically determined according to the type of incoming source signal. However, if your source is jittery and/or tearing you may wish to “force” a setting to ensure stable processing for this source—if desired, override the default “Auto” setting by selecting the appropriate motion filter:

1. Auto
▶ 2. Still
3. Motion
4. Film

1. **AUTO:** The projector will automatically use the correct motion filter according to the incoming signal.
2. **STILL:** For static images with no motion, such as graphics from a CD.
3. **MOTION:** For video images that did not originate from film, or for moving computer-generated images.
4. **FILM:** For video images that originated from film. This will optimize image quality and stability.

FILM MODE THRESHOLD — This setting determines how sensitively the projector can detect if an incoming video signal originated from film or not. It should not require adjustment.

DETAIL THRESHOLD — Use “Detail Threshold” to define at what frequency level the “Detail” control will begin to magnify high frequencies, which adds details back into the image. Raise the threshold to *ignore* more of these high frequencies, and lower the threshold to *magnify* more of these frequencies. A setting of “0”, for example, means no noise will be ignored and all will be magnified. An ideal detail threshold is one in which high frequencies that are causing objectionable noise are *not* magnified when using “Detail”, but frequencies which can help sharpen an overly-soft image are magnified.

3D SOURCE — When using a Mirage projector with HD or WUXGA resolution, a checkbox option called **3D Source** will be added to the bottom of the *Advanced Image Settings* menu. This checkbox must be set by the user for all new 3D sources, and cleared for all new non-3D sources (default setting is checked). Once set, this value will be maintained for that source for all future uses. This option is also available under the *Simulation 3D* menu in Mirage HD projectors only.

FLOATING INPUTS - This allows the signals connected to inputs 1, 3, and 4 to have floating ground references relative to the projector. Floating the inputs can remove hum bars in the image if the installation has conflicting grounds. However, floating the inputs can also introduce hum bars when the signal ground is the only connecting ground. Select the setting that produces the best image.

3.6 Adjusting System Parameters and Advanced Controls

Use the *Configuration* menu to define general operating parameters and communications with other projectors and equipment, and to access other advanced processing and image adjustments affecting overall performance. In addition, the *Configuration* menu provides access to diagnostics, calibration tools and the *Service* submenu (password-protected).

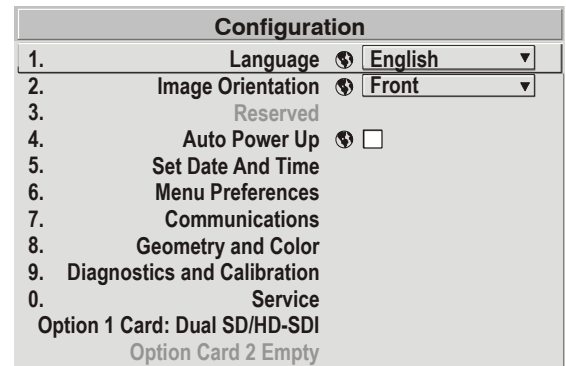

Keep in mind that settings in the *Configuration* menu (and its submenus) are typically “global” settings applied regardless of the type of source being used. This characteristic is identified with the 🌐 (globe) icon alongside the option.

NOTE: *The Configuration menu is recommended for experienced users/technicians only.*

System Configuration — GENERAL —

▶ The first six options in the *Configuration* menu are explained below:

Language

Choose from available languages to use in the projector’s menus. The change will take effect immediately.

Image Orientation

Set the orientation of the image according to the orientation of your projector. If the setting is incorrect, projected images will be reversed and/or upside down.

Reserved - No function.

Auto Power-up

Enter a checkmark to enable the projector to automatically power up after losing power due to a power failure or due to unplugging the projector during operation. Note that unsaved display adjustments may be lost.

Set Date & Time

Enter/read the current year-month-day and hour-minute-second. Changes here reset the projector’s real-time clock.

Menu Preferences — SUBMENU

Adjust the appearance, content and/or location of on-screen menus and messages.

LARGE MENU FONT — Enter a checkmark to enlarge menus and their text. You may have to adjust “Menu Location” to accommodate the increased menu area.

Menu Preferences	
1.	Large Menu Font <input checked="" type="checkbox"/>
2.	Menu Location <input type="text" value="4:3 Top/Left"/>
3.	Horizontal Shift <input type="text" value="261"/>
4.	Vertical Shift <input type="text" value="204"/>
5.	Display Channel List <input type="checkbox"/>
6.	Display Slidebars <input type="checkbox"/>
7.	Display Error Messages <input type="text" value="All"/>
8.	Splash Screen Setup <input type="text" value="Always on"/>

MENU LOCATION — Use the pull-down list to choose a pre-defined default or customized location for the display of all on-screen menus.

To create a custom menu location quickly, choose a preset that is closest to the desired location. Then adjust “Horizontal Shift” and “Vertical Shift” slide bars to move the menu to the desired location. Avoid locations too close to a corner or edge to prevent cropping of larger menus.

HORIZONTAL SHIFT AND VERTICAL SHIFT — Shift your menus as desired, creating a customized menu location.

DISPLAY CHANNEL LIST — Enter a checkmark if you want to see a scrollable channel list whenever you press from your presentation. Channels marked with a list icon in the *Channel Setup* menu will appear here. The “Display Channel List” option also enables on-screen feedback when using the key. If you prefer to hide the channel list and input dialog box while switching channels and sources during a presentation clear the checkbox.

NOTE: *The Channel List and input dialog box cannot be hidden during use of the menus.*

DISPLAY SLIDE BARS — Enter a checkmark to superimpose a small slide bar over the current image whenever an adjustable parameter is selected directly with a key such as or . If “Display Slide bars” is unchecked, these slide bars can still be accessed, but will be hidden during adjustment. This option does not affect slide bars in menus.

DISPLAY ERROR MESSAGES — Choose how you want to be notified of errors detected in either the incoming signal or projector. Select “Screen” or “All” (default) to see brief on-screen messages. This is particularly recommended during setup or testing of the projector. Or select “Serial Ports” to receive messages via RS232 or RS422 serial communication only. To hide error message displays, such as during shows and presentations, select “Off” or “Serial Ports”.

SPLASH SCREEN SETUP —Use the Splash Screen to choose when you would like to display a special introductory splash screen image, such as your company logo, graphic or message.

- Always Off = A splash screen never appears
- Always On = A splash screen is always on behind the current display image, similar to wallpaper.
- Start-up Only – The splash screen logo appears at projector start-up only.
- Start-up And No Signal – A splash screen appears at start-up only if there is no source signal.

To replace the default “Christie logo” splash screen (or other) with one of your own, use *KoRE Librarian* to download the desired .bmp to the projector. This will overwrite the current splash screen content in projector memory.

System Configuration
— COMMUNICATIONS —

▶ Settings in the *Communications* submenu define and control how single or multiple projectors are linked with each other and with a controlling device.

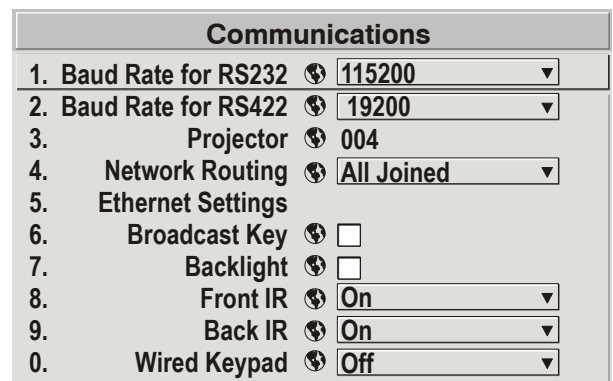

Baud Rates

The baud rate setting determines the speed of communication to and from the projector on the RS232 or RS422 links. The maximum rate for the RS232 is 115200; for RS422 it is 19200.

Set the baud rate to match that of your controlling device, such as your PC. If you are unsure about what baud rate to choose, refer to the documentation for the controlling device. In an existing network of projectors, if you discover that a projector has a different baud rate, use the pull-down list and select the correct baud rate using the **←** key—do not just scroll this control with **←** or **→** keys. Serial communication is always eight data bits, no parity.

Projector

Enter a three-digit number (such as “001”) to assign or change a number to the projector currently in use. If the current projector already has a number assigned, that number will appear here (for example, “004” in the menu shown above). Numerical identity for projectors enables you to communicate with a single projector within a multiple-projector application (see also **Proj** key in 3.2, *Using the Keypads*). If you make a mistake in assigning or changing the projector number, press **Exit** to cancel.

NOTE: *When multiple projectors are being used and you want to adjust the color and edge blending settings for individual projectors to create one seamless image, you must assign different numbers for each projector to allow switching back and forth between projectors while adjustments are being made.*

Network Routing

NOTE: Not applicable for stand-alone projectors or simple serial networks with only one type of controller and linking.

- | | |
|------------------------------|--|
| ▶ 1. Separate | = Networks do not communicate with one another |
| 2. RS232 and RS422 Joined | = Serial networks are joined, but Ethernet is isolated |
| 3. RS232 and Ethernet Joined | = RS232 and Ethernet are joined but RS422 is isolated |
| 4. All Joined | = Network communications travel all networks |

SEPARATE: Select “Separate” (factory default) to keep RS232, RS422 and Ethernet messages on their respective paths instead of being broadcast to the other types of ports. In Figure 3.8A, RS422 controls only the projector to which it is connected. In Figure 3.8B, either RS232 or RS422 will control the network.

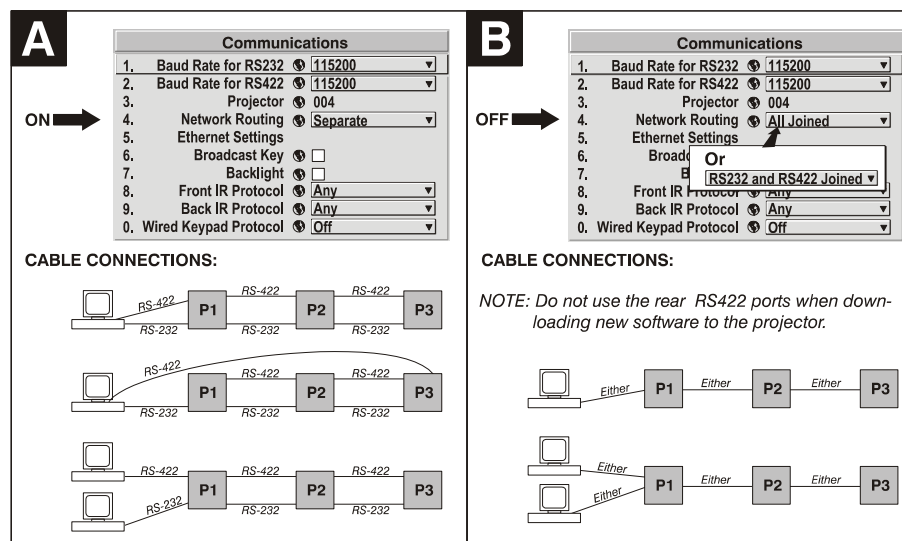

Figure 3.8. Using the “Network Routing”

RS232 AND RS422 JOINED: Messages originating from an RS232 or RS422 controller will be relayed to all RS232 or RS422 ports. Any Ethernet communication, however, will not.

RS232 AND ETHERNET JOINED: Messages to and from the RS232 ports will also be relayed to the Ethernet port, and vice versa. Any RS422 communications will be isolated.

ALL JOINED: All messages reach all ports, regardless of type.

Ethernet Settings (SUBMENU)

NOTE: Recommended for network administrators only.

DHCP: Enable this checkbox if you want a DHCP server to automatically change the projector’s default IP address (0.0.0.0) to one that is valid and unique for use on the current Ethernet network. On networks without a DHCP server, or to simply override the automatic DHCP server function, delete the checkmark and enter the new “IP Address” settings desired. Remember that only a 0.0.0.0 address will trigger the DHCP addressing service, and only when the DHCP checkbox is enabled.

Ethernet Settings		
1.	DHCP Enabled	<input checked="" type="checkbox"/>
2.	IP Address	000.000.000.000
3.	Port	3002
4.	Subnet Mask	000.000.000.000
5.	Default Gateway	000.000.000.000
6.	Network Name	<input type="text"/>
7.	ArtNet Interface Settings	

= Projector's IP address will be DHCP-assigned
 = Use static address assigned in "IP Address"

IP ADDRESS: Enter a valid and unique IP address for use on the network to which the projector is currently connected. This address will overwrite any previous IP address such as the projector's factory-defined default (0.0.0.0), or one that has been assigned by a DHCP server or other user. It takes approximately 10 seconds for the projector to respond at its new address.

PORT: On some Ethernet networks, firewall restrictions may require that the port number of the projector be changed from its default of 3002. If so, enter a new valid port number here. It is highly recommended not to use a port # below 1024, as these ports are typically reserved for and used by common IP applications.

SUBNET MASK AND DEFAULT GATEWAY: The Subnet Mask and Default Gateway are automatically assigned when DHCP is enabled. If a static IP is being used, the IP must be assigned first since the projector estimates the subnet mask after the IP is entered. The Default Gateway is an optional router device used to send and receive data outside the subnet.

NETWORK NAME: Set the name for the projector, as it should appear on the local network. The control is most useful when DHCP is enabled, since the IP address may change from one session to another.

ArtNet Interface Settings — SUBMENU

ArtNet is an Ethernet communication protocol that was developed by Artistic License. It is used for controlling lighting/staging equipment from a lighting console or PC application. It is based on the popular DMX512 control protocol.

ArtNet Interface Settings		
1.	ArtNet Subnet	00
2.	ArtNet Universe	00
3.	ArtNet Advanced Mode	<input type="checkbox"/>
4.	ArtNet Base Channel	001
5.	ArtNet Device Name	Christie
6.	ArtNet Device Description	Christie / ArtNet Interface

ArtNet SUBNET: This is the highest level address for a device. Typically it is set to 0.

ArtNet UNIVERSE: Each packet of data is broadcasted to all devices plugged into a universe (up to 512 devices/channels).

ArtNet ADVANCED MODE: When this setting is enabled, each projector listens for data on 64 channels starting with the base channel. When advanced mode is not in use, the projector only listens on 10 channels. You can squeeze more devices per universe when the projector uses fewer channels.

NOTE: *The additional 54 functions are not currently implemented and are reserved for future use.*

ArtNet BASE CHANNEL: When advanced mode is enabled, the projector listens to data on 64 consecutive channels, or 10 consecutive channels when advanced mode is not enabled. The projector processes requests that come on either 10 or 64 consecutive channels beginning with the ‘base channel’ defined here. The requests implement the following functions:

DMX Channel	Function	Value	
Base	Shutter	0 – 64 65 – 192 193 – 255	Open No Action Closed
Base + 1	Slider Lock	0 – 254 255	Locked Unlocked *
Base + 2	Input *	1 – 8	Input #
Base + 3	Channel *	1-99	Channel #
Base + 4	Lens – Vertical * †	0 1 – 254 255	Lens Down Stop Lens Up
Base + 5	Lens – Horizontal * †	0 1 – 254 255	Lens Right Stop Lens Left
Base + 6	Lens – Focus * †	0 1 – 254 255	Negative Focus Stop Positive Focus
Base + 7	Lens – Zoom * †	0 1 – 254 255	Zoom Out Stop Zoom In
Base + 8	Power *	0 1 – 254 255	Power Off No Action Power On
Base + 9	None		

* Functions are only active when the Slider Lock is set to Unlocked

NOTE: It is important to ensure the channels DO NOT overlap another device.

Example:

Good	Bad
Proj1_Base = 0	Proj1_Base = 5
Proj2_Base = 10	Proj2_Base = 9
Proj3_Base = 20	Proj3_Base = 11

ARTNET DEVICE NAME: This option is used to name each device; some ArtNet servers support querying for devices. Press Enter and use the arrow keys to enter a name.

NOTE: Refer to section 3.4 Navigating the Menus, Edit numerical Values, for text entry description.

ARTNET DEVICE DESCRIPTION: More information that is returned when a “device query” has been done.

Broadcast Key

Enter a checkmark if you want keypad commands sent to one projector to be relayed to all projectors in a serial network. Note that the (Proj) key will temporarily “override” the effect of a broadcast setting and allow you to control a specific projector when necessary. Disable the setting for all but one (any) projector in a network.

Backlight

Toggle to turn the built-in keypad backlighting on and off.

Front IR / Back IR

As needed for your application, set to “any” so that the front and/or rear IR sensor locations on the projector respond to the IR keypad. Set to “off” to disable.

To disable *both* IR sensors, you cannot use the IR remote keypad to select the second **OFF** setting. This safeguard prevents accidentally disabling an IR keypad while you are using it. Instead, use either the built-in keypad or a wired remote (optional) to set the remaining active sensor to **OFF**. The projector will no longer respond to an IR remote keypad.

NOTE: *Protocols B – G are used for rental staging applications.*

Wired Keypad

The wired keypad is ON by default when connected to the rear of the projector. The projector will then respond to incoming commands from this port. To disable the wired keypad, you must use a different keypad—the built-in or an IR remote keypad—to select “off”. This safeguard prevents you from accidentally disabling the wired keypad during use.

System Configuration
— GEOMETRY & COLOR —

► In the *Configuration* menu, select the *Geometry and Color* submenu when you need to modify overall color performance and/or image geometry for all sources.

Test Pattern

Choose the desired internal test pattern, or select OFF to turn off a test pattern. Alternatively, use the  key for cycling through test patterns.

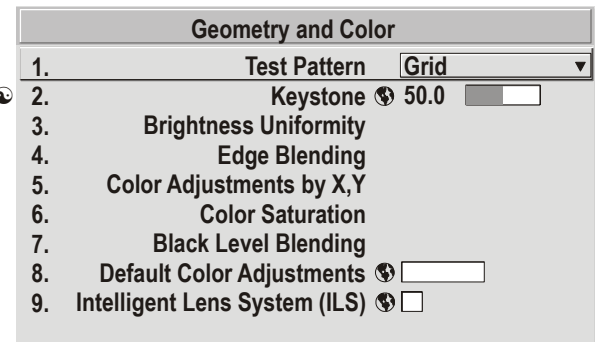

 **Keystone and Warping** if ChristieTWIST warping module is present (standard in Matrix models, optional in all others).

Keystone

NOTES: **1)** *If the optional Christie TWIST module is installed, this option is Keystone and Warping, and activates a submenu for defining custom image shapes. Please refer to documentation included with your Christie TWIST module.* **2)** *If you have a WU model and Christie TWIST is not installed, Keystone is not available.*

Use to correct a keystoneed image shape in which both sides of your image are inclined toward the top or bottom edge. Tilting the projector in relation to the screen typically causes keystone; the lens surface and screen are no longer parallel to each other.



Figure 3.9. Keystone Adjustment

Brightness Uniformity — SUBMENU

Brightness Uniformity provides further refinement of displays already matched for their primary colors and overall light output. Use *Brightness Uniformity* to create an exceptionally smooth image in which no area appears brighter and/or more red, green or blue than another. In the *Brightness Uniformity* menu, enable the “Uniformity Enable” checkbox to access a multitude of adjustments for critical color light output control in specific areas throughout the image. Your settings apply as long as the “Uniformity Enable” checkbox is enabled and you are using a “User” color temperature defined by the *Brightness Uniformity* controls. To disable the *Brightness Uniformity* function, delete the “Uniformity Enable” checkmark.

NOTES: 1) See also 3.10, *Using Multiple Projectors* for the complete step-by-step procedure for achieving uniform brightness in adjacent displays. **2)** If Christie TWIST module is installed, the enable checkbox changes to a list giving the option to choose from several different uniformity maps. Please refer to documentation included with your Christie TWIST module.

Edge Blending — SUBMENU

The *Edge Blending* submenu provides a range of controls for smoothing together the overlapping bright edges of multiple adjacent projected images to create a single larger “seamless” image. These controls, which primarily affect white levels, are typically used in conjunction with mechanical lens blinders (optional), which are installed on the front of the projector and which primarily affect black levels. There is a centerline (both horizontal and vertical) in the *Edge Blending* test pattern. The intersection of these lines is the true center of the projector’s display area.

NOTES: 1) There is a centerline (both horizontal and vertical) in the *Edge Blending* test pattern. The intersection of these lines is the true center of the projector’s display area. **2)** See also 3.10, *Using Multiple Projectors*.

Color Adjustments by X/Y, and Color Saturation — SUBMENUS

NOTES: 1) For defining or changing a User 1, 2, 3, or 4 color performance or “gamut”. Sometimes known as *Comprehensive Color Adjustment™*. **2)** Factory-defined primary color levels, which ensure a specific color performance from projector-to-projector, can be calibrated in the *Service* menu only. If you suspect alteration of these defaults, the factory settings can be recovered with selection of “Reset to Factory Defaults?” in the *Color Primary Settings* submenu accessed via the *Service* menu (password-protected).

From the factory, the projector can utilize any of the three pre-defined color performance settings identified at right (default=Max Drives), or colors can be driven on the basis of color temperature. For most applications, one of these gamuts will produce accurate and realistic colors from a variety of sources. They can be applied at any time in the *Advanced Image Settings* menu (“Select Color Adjustment”), and are not adjustable.

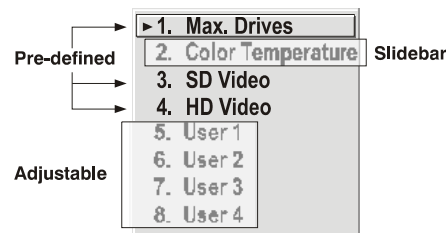

DEFINING “USER” COLOR GAMUTS: In some cases, you may find that none of the pre-defined “Select Color Adjustment” options exactly suit your needs. For example, you may require a unique color gamut (range) for a single projector or application, or you may need to precisely match colors across multiple adjacent displays. In such cases, use the *Color Adjustments by X,Y* or *Color Saturation* submenu to define the precise hue of each primary color component (red, green, blue, and white) used to generate the millions of colors produced in displays. You can create up to four custom color gamuts (User 1, 2, 3, or 4) with these adjustments.

Note that the two menus differ only in their user interface, so use whichever menu best suits your needs and application. A color meter can help with adjustments.

- *Color Adjustments by X,Y* — Enter known x/y coordinates from the chromaticity graph.
- *Color Saturation* — Adjust color slide bars and judge image color by eye or meter.

A user-defined color “adjustment” can be applied by selecting it in the *Advanced Image Settings* menu (“Select Color Adjustment”).

COLOR ADJUSTMENT BY X,Y: Use this submenu if you want to create, alter or copy a color gamut (i.e., “color adjustment”). Controls in this menu define the precise hue of each primary color component (red, green, blue, and white) used to generate the millions of colors produced in displays. The x/y coordinates for each color define its location on the standard CIE chromaticity graph (see Figure 3.10)—changing either or both of these numbers will change the hue of the color, and relocate the “triangle” for possible colors. For example, changing the x/y coordinates for red may move the color closer to orange or closer to violet, which will in turn affect all displayed colors having a red component. Adjust the slide bars or enter new specific coordinates as desired to define or change up to four “User” color gamuts needed for your environment and applications. Apply at any time in the *Advanced Image Settings* menu.

Color Adjustments by X,Y			
1.	Select Color Adjustment	User2	
2.	Color Temperature	6521	<input type="text"/>
3.	Red X	0.655	<input type="text"/>
4.	Red Y	0.341	<input type="text"/>
5.	Green X	0.332	<input type="text"/>
6.	Green Y	0.575	<input type="text"/>
7.	Blue X	0.144	<input type="text"/>
8.	Blue Y	0.093	<input type="text"/>
9.	White X	0.320	<input type="text"/>
0.	White Y	0.330	<input type="text"/>
Auto Color Enable		<input checked="" type="checkbox"/>	
Color Enable		Red	▼
Copy From		Max Drives	▼

Figure 3.10. Customize Color

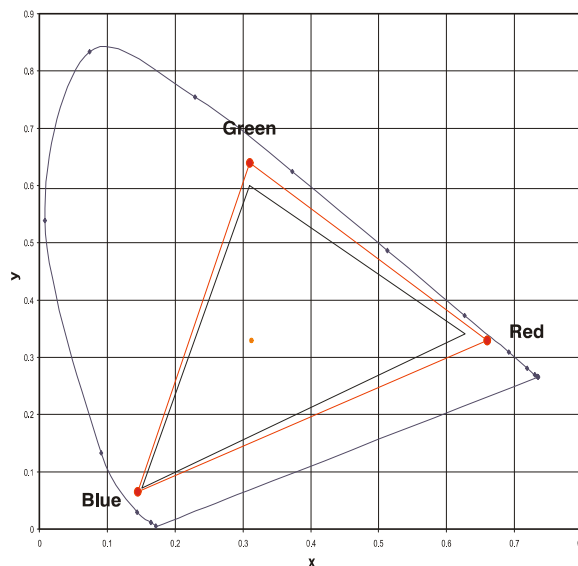

Figure 3.11. CIE 1931 Chromaticity Diagram (without Yellow Notch Filter)

NOTE: Keep new x,y coordinates within the original color gamut triangle shown here.

PROCEDURE FOR X,Y ADJUSTMENTS: See 3.10, *Using Multiple Projectors.*

COLOR SATURATION: Use this submenu if you do not have specific color coordinates in mind and will simply judge color performance by eye or meter. Like the *Color Adjustment by X,Y* submenu, each color control actually defines new x/y coordinates for that color and changes its hue—it is just a different interface.

Adjust the hue of each primary color (red, green, blue, and white) by using more or less of it in relation to the other colors.

Color Saturation	
1.	Select Color Adjustment User 4
2.	Color Temperature 6521 <input type="text"/>
3.	Red Color Adjustment
4.	Green Color Adjustment
5.	Blue Color Adjustment
6.	White Color Adjustment
7.	Auto Color Enable <input type="checkbox"/>
8.	Color Enable White <input type="text"/>
9.	Copy From Color Temperature <input type="text"/>
0.	Lamp

NOTE: A *Color Saturation* adjustment defines the corresponding x/y coordinates shown in the *Color Adjustment by X,Y* submenu. These x/y coordinates will remain stable for this User gamut until they are changed again via either menu. Values displayed in the *Color Saturation* menu, however, will likely fluctuate as you use the projector, and will be different when you return to this menu at some point in the future. These floating changes do not affect the x/y coordinates or gamut.

Black Level Blending — SUBMENU

Black Level Blending is a feature that eliminates the differences between black levels when edge blending multiple projectors. The *Black Level Blending* submenu provides many controls to allow the edges of adjacent images to be smoothly overlapped creating a “seamless” image. Black Level Blending provides a simple solution for uneven black levels, without the need for external hardware, by matching up black level hues with a “target area” hue (the intersection of the center lines), and adjusting the overlaps (edges) surrounding the target area.

The use of Black Level Blending feature and the use of Christie TWIST module are mutually exclusive. On a WU model, Keystone is only available when Christie TWIST is in use. If Christie TWIST is installed and Black Level Blending is desired:

1. Disable use of warps or 2D Keystone.
2. Enable edge blending; if not enabled.
3. Enable Black Level Blending.
4. Power down the projector then power up again.

Adjustments can now be made to black level controls.

To restore the use of Christie TWIST:

1. Disable black blending.
2. Power cycle the projector.
3. Begin using the TWIST controls.

NOTES: 1) Refer to section 3.10, *Using Multiple Projectors* for additional information. **2)** There is a centerline (both horizontal and vertical) in the Black Level Blending test pattern. The intersection of these lines is the true center of the projector’s display area. **3)** Adjust white levels before adjusting black levels. **4)** Blinders are recommended for fixed installations.

Default Color Adjustments — SUBMENU

Refer to *System Configuration – Geometry and Color, Color Adjustments by X,Y* for description.

Intelligent Lens System (ILS™) — SUBMENU

ILS™ provides the ability to recall focus and zoom settings specific to each source input. Custom lens settings you’ve chosen for any source will be quickly and accurately applied when you select a source that has already been calibrated. Place a checkmark in the checkbox to enable ILS™. If no calibration has previously been done you may be prompted to do a full calibration. If a motion calibration has been done, you will be prompted to complete a reference calibration. If both calibrations have been done, the checkbox will be checked and ILS™ enabled. If ILS™ is enabled, a reference calibration will be done on power up and the lens will return to the saved position of the source that is active at the time of power up or to the position the lens was located when it was powered on. Further adjustments to the zoom, focus and position will be automatically saved for source the selected source. If you switch to a source with different lens settings and switch back, the lens will automatically move to your saved settings upon return. Other sources can be used without using ILS™.

NOTES: 1) See *System Configuration – Diagnostics/Calibration, ILS Calibration* for further details about calibration. **2)** ILS™ control is a preference setting and will be retained between power cycles.

System Configuration DIAGNOSTICS / CALIBRATION

► Test Pattern

Choose the desired internal test pattern to display, or select OFF to turn off a test pattern. Alternatively, use the  key for cycling through test patterns.

NOTE: There is a centerline (both horizontal and vertical) in the Edge Blending test pattern. The intersection of these lines is the true center of the projector's display area.

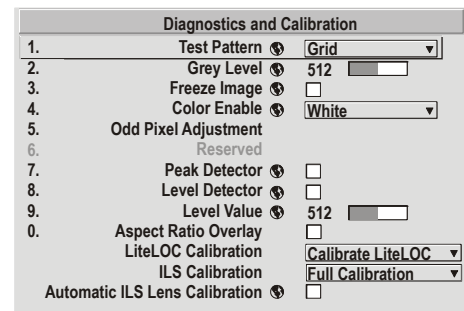

Test Pattern Grey Level

Set the desired level of grey for displaying in the full gray field test pattern.

Freeze Image

Enter a check mark to freeze (stop) an image on a single frame. This diagnostic tool is useful if you need to examine in detail a still version of an incoming image that cannot be “frozen” at the source. For example, in moving images it is sometimes difficult to observe artifacts such as external de-interlacing/resizing and signal noise. Remove the checkmark to return back to normal.

Color Enable

Select which color or colors you want to see. This is useful while working with color temperature, input levels or other special setup parameters. Colors can also be enabled/disabled by entering the corresponding function code listed on the back of the standard remote keypad.

Odd Pixel Adjustment

NOTES: 1) Factory-set and rarely required by user. **2)** Source must be >90 MHz.

When using certain RGB sources, you may need to adjust the normal gain or offset of odd pixels in relation to even pixels. This will smooth out very narrow (one-pixel wide) “checks” or vertical stripes that indicate adjacent “on” and “off” pixels. Using the Level Detector simplifies this process (see Figure 3.12):

1. Use an external analog native-sized continuous grayscale test pattern with at least 256-levels.
2. Turn “Level Detector” on.
3. Set “Level Value” to ~200. The image should now be black-and-white (or black-and-one color, if you use “Color Enable” function).
4. Adjust *offset*. Half of the pixels will move and the other half will not.
5. Adjust until the two transition regions overlap. The stripe of noise will be minimized, defined by the value in the slide bar.
6. Set “Level Value” to ~800. The image should now be black-and-white.
7. Repeat Steps 4 and 5, but adjusting *gain*.

8. Repeat Steps 3-7 for all remaining colors. Your RGB source should now be OK.

Two sets of values are automatically saved with these controls—one value for Input #1, and one for Input #2 (analog). The current set of values depends on which source is in use. This enables a source to be processed correctly via two different inputs.

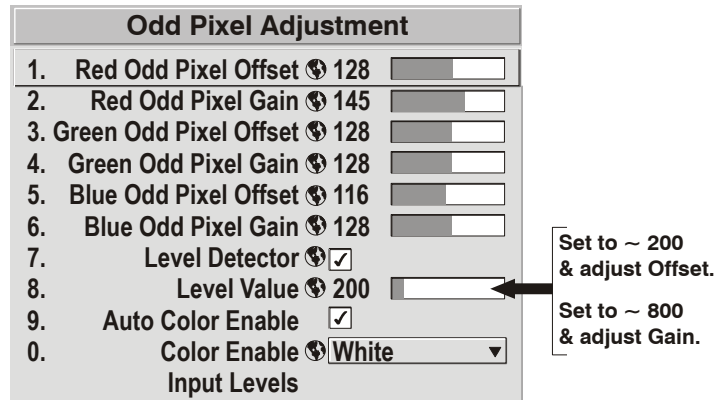

Figure 3.12. Using “Odd Pixel Adjustment”

NOTES: **1)** Adjust offset before gain, since offset affects gain. **2)** A value of 128 represents no change in normal odd pixel offset or gain. **3)** Odd Pixel Adjustment eliminates “one pixel on, one pixel off” artifact only, not any type of larger artifacts.

Reserved - No function.

Peak Detector

The “Peak Detector” is a fast method for defining individual input levels, and can improve the accuracy of input levels set by the Auto Input Level function. Enabling the “Peak Detector” activates a special operating mode for detecting *only* pixels that are considered black or white—all other levels are displayed as a mid-level gray. When used with a 16-step grayscale pattern in which the two black and white bands are known to be at opposite edges of the image, you can watch these isolated areas while adjusting individual black levels and input drives until both bands are just visible. Images from this source will then display correct blacks and whites without crushing or washing out.

NOTE: *If using Peak Detector with PIP, both images must have the same color space.*

Level Detector

The “Level Detector” checkbox enables specific thresholds for blacks and whites—input levels that fall below a specified *Level Value* (see below) are displayed as black, and all others are displayed as white. It aids in Odd Pixel Adjustment. To use:

1. Enable “Level Detector” and display a continuous grayscale.
2. Set “Level Value” to near black (such as 200).
3. Adjust Offsets to minimize area of black stripe.
4. Set “Level Value” to near white (such as 800).
5. Adjust Gains to minimize area of white stripe.

Level Value

Level Value defines the value to be used by the Level Detector in recognizing blacks and whites. See *Level Detector*, above.

Aspect Ratio Overlay

Selecting this option with a checkmark will overlay a number of common aspect ratio boxes on top of the source image. This is very helpful during the setup of the projector and can be turned off after desired specifications have been achieved.

LiteLOC™ Calibration

NOTES: 1) *LiteLOC™ Calibration* takes up to two minutes. 2) For best results, allow the projector to warm up for 15 minutes prior to calibration.

LiteLOC™ Calibration defines the range of power needed to maintain lamp brightness. Select *Calibrate LiteLOC* for calibration using your projector's unique specifications (recommended) rather than standard specifications. The projector will revert to the default back-up in the event of a power failure.

- | |
|---|
| <ul style="list-style-type: none"> ▶ 1. Use Default Settings 2. Calibrate LiteLOC |
|---|

Intelligent Lens System (ILS™) Calibration

This option allows you to choose between three types of lens calibrations. *Reference calibration* determines a reference point that is used as a defined starting position for relative motion of the lens. All positioning is measured from this reference point. A *reference calibration* is lost when power is removed from the projector and will occur on every power up as long as ILS™ is enabled. A *motion calibration* determines the characteristics of each motor and values are saved in the projector's memory. If ILS™ is enabled and a *motion calibration* has previously been done, the projector will automatically recall these settings from memory when it's being powered up and a *motion calibration* will not take place. A *full calibration* performs both a *reference* and *motion calibration*.

- | |
|--|
| <ul style="list-style-type: none"> ▶ 1. Reference Calibration 2. Motion Calibration 3. Full Calibration |
|--|

Automatic ILS Lens Calibration

When this option is selected (default) and the projector is in ILS mode, the projector will perform a lens calibration on each power-up. During calibration, the shutter will be closed and the status LED will display 'LC'. If ILS is not selected, the ALC setting will be ignored. If, during power-up, ALC is not selected and ILS is, the last stored location from the previous ILS calibration will be assumed to be true and the lens will moved to that position upon power-up if necessary.

System Configuration
OPTIONAL INPUT MODULES

► The two “Option Card” entries in the *Configuration* menu identify which optional input modules (a.k.a. *cards*) are present at **INPUT 5** (Option 1) and **INPUT 6** (Option 2). If either of these option slots is empty, the corresponding read-only menu entry does nothing. If there is a module installed, the corresponding menu entry may activate a submenu of further options pertaining to that module.

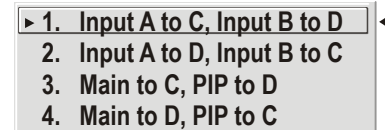
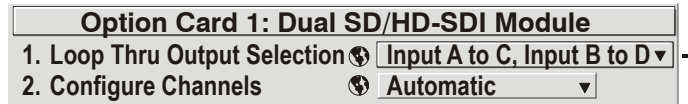

For example, if the *Dual SD/HD-SDI* module is installed at **INPUT 5** (Option 1). The Option 1 Card submenu provides controls for configuring the various connections on this multi-input, multi-output module. As desired for your application, you can define 1) which physical input loops through to which output, and 2) which functional input (main or PIP signal) loops through to which output.

System Configuration ►
CONFIGURE CHANNELS -
SUBMENU

Select Automatic mode or a series of manual modes. In Automatic mode the input video payload information is read and compared to that of the SMPTE 352 standard to detect the dual link format and the primary channel. Single video input will also work in this mode without any payload information. Dual link input video which does not contain payload information must be set up manually. Select the format and which of the two channels is the primary input.

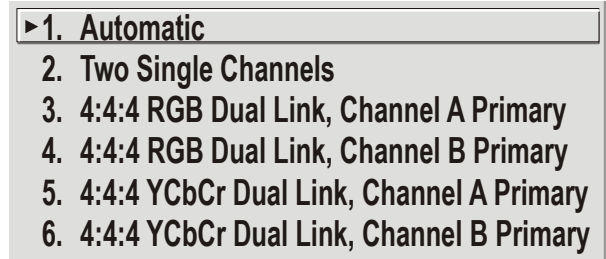

3.7 Working with PIP or Seamless Switching

PIP (Picture-in-Picture) and Seamless Switching are independent but related projector features that both utilize two image-processing paths within the projector. In the case of Picture-in-Picture, this double processing enables you to display two different images simultaneously – typically a smaller “secondary” image within a large “primary” background. In a seamless switch, the double processing essentially occurs between displays so that a full image relayed from one source can smoothly transform into a full image from another source. This change can be virtually instantaneous, or slowed as desired so that the current image appears to dissolve or “fade” into the new image. **NOTE:** *PIP and Seamless Switching are not available on WU models.*

Options for enabling and controlling PIP and Seamless Switching all reside in the same menu. Note, however, that because both features utilize the projector’s double processing capability, PIP and Seamless Switching cannot be used together. For example, fading a pair of PIP images into a new display from a different source is not possible.

For best PIP or Seamless Switching results, use two *different* signal types* as defined below. Do not mix two signals of the same type.

Signal Type	Description (Input Location)
#1	5 BNCs (RGBHV or YPbPr)
#2	DVI - I (analog or digital)
#3	Decoded signals (Input 3, Input 4, Composite video, S-Video, or any video signal via Input 1 BNC connectors or via an analog option card).
#4	Analog Option Cards
#5	Digital Option Cards
#6	Digital Option Cards

* HD interlaced sources are not recommended for the PIP window.

Other PIP or Seamless Switching tips to keep in mind include:

- When using two digital signals or one analog and one digital, each must be ≤ 165 megapixels.
- When using two analog signals, each must be ≤ 90 megapixels.
- Avoid using an interlaced source in the PIP window
- Seamless switching may affect image quality in some cases

Working with PIP ► **NOTE:** To control the primary image, access all picture controls through the Main menu. To control the secondary (PIP) image, access picture controls through the Picture-in-Picture and Switching menu.

Use the first of six options in the *PIP and Switching* menu to enable and define how you want to use PIP.

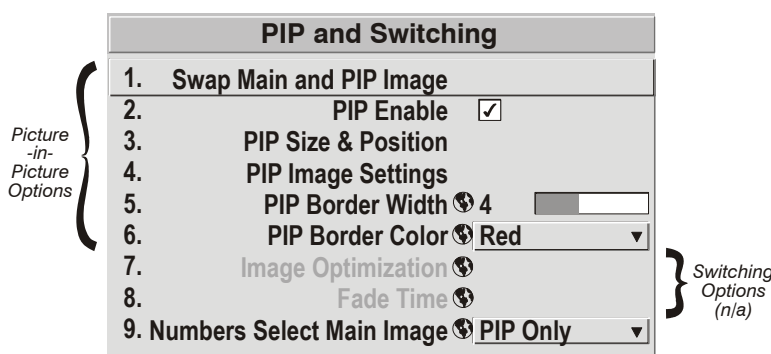

Swap Main and PIP Image

Toggle the current picture-in-picture relationship so that the primary (main) image becomes secondary (PIP), and the secondary image becomes primary. Swapping is available only when PIP is enabled.

NOTE: There may be a slight delay when swapping the Primary and Secondary images.

PIP Enable

Short cut: Press on the Remote if menu not present.

Toggle to display from two sources at once (Picture-in-Picture) or the primary source only. This checkbox turns the secondary source on and off.



NOTE: Disable PIP and Best Switching for Interlaced sources > 35kHz.

PIP Size and Position – SUBMENU

Most controls in the *PIP Size and Position* menu adjust the PIP (secondary) image in the same fashion as their counterparts in the main *Size and Position* menu adjust the main image—see 3.6, *Adjusting the Image* for details. Exceptions are:

PIP Size and Position		
1.	Position Presets	Bottom Right ▾
2.	Size	0.729 <input type="text"/>
3.	Vertical Stretch	1,090 <input type="text"/>
4.	Pixel Track	858 <input type="text"/>
5.	Pixel Phase	0 <input type="text"/>
6.	H-Position	360 <input type="text"/>
7.	V-Position	262 <input type="text"/>
8.	Aspect Ratio Presets	Anamorphic ▾
9.	Reserved	
0.	Advanced Size and Position	

POSITION PRESETS –Set the location of the PIP (secondary) image in the display.

ASPECT RATIO PRESETS – Choose the desired aspect ratio for your PIP pixels. Use the “Default” aspect ratio when incoming format has square pixels (most common). This ensures that the resulting PIP image maintains its intended aspect ratio. Use “Anamorphic” for NTSC signals having narrower pixels--this will stretch the pixels horizontally to regain the intended aspect ratio of the PIP image.

NOTE: *If the image is already resized at the source it will remain that way in the PIP window. If, for example, an NTSC signal is already set to anamorphic through the Resize and Preset menu it will remain that way in the PIP window. If the NTSC signal is formatted as widescreen at the source, then the image in the PIP window will appear with black bars above and below it.*

PIP Image Settings — SUBMENU

Adjust the PIP (secondary image) without affecting the size or position. The primary image remains unchanged. See 3.6, *Adjusting the Image* for details

PIP Border Width

Set the desired line thickness for your PIP window border.

PIP Border Color

Select the desired color for the PIP window border.

NOTES: **1)** *Numbers 7 and 8 on the Picture-in-Picture and Switching submenu control switching parameters. 2)* *Disable PIP in order to work with Seamless Switching. 3)* *Disable PIP and Best Switching for Interlaced sources > 35kHz.*

Working with Seamless Switching

▶ Seamless Switching is the ability to instantly and/or smoothly switch sources, and is controlled with options 7 and 8 in the *PIP and Switching* menu. To use Seamless Switching, PIP must be disabled. **NOTE:** *On WU models, both Seamless Switching and PIP are not available and image optimization defaults to Best Image Quality.*

Tips for best source switching:

- Ensure a channel has been configured for each source.
- Progressive digital and analog sources are recommended.
- Set Image Optimization to Seamless Switching (see below).
- For best results, use the same frame rate and gamma setting for each.

NOTE: *Avoid using two interlaced sources.*

Image Optimization

Use this setting to choose what is more important, image quality or switching between sources. Selecting *Best Image Quality* will ensure your image is always proper however when switching sources, the screen will go blank increasing your switching time. *Smooth Switching* allows for a cleaner transition between sources. The image will fade from one image to another according to the *Fade Time* control. *Seamless Switching* overrides the *Frame Lock Enable* settings and forces the output to run at 60Hz regardless of the input signal. Image is 100% seamless when switching sources.

NOTE: *Disable PIP and Best Switching for Interlaced sources > 35kHz.*

Fade Time

Set how long (in seconds) it takes to gradually dissolve one image into another for a source switch when Image Optimization is set to Smooth Switching.

NOTE: *PIP must be disabled for Fade Time to take effect. Also, the PIP window must be closed to activate it.*

Numbers Select Main Image

Use *Numbers Select Main Image* to use the numeric keys #1-8 as input keys. This remapping of the keypad (see right) can be particularly useful with PIP displays, providing a convenient shortcut for changing the primary (background) image without first having to return to the *Main* menu. Select “Always” to use the keys in this manner all of the time, even with single displays. For normal keypad function, select *Never* (default). Set to *When PIP Active* to activate number keys only when PIP is in use.

NOTE: *Numbers Select Main Image keypad functionality works only when menus are closed.*

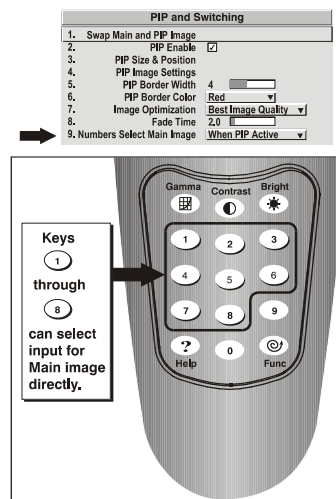

3.8 Working with the Lamp

Whenever you install a new lamp in the projector, access the *Lamp* menu to record the lamp serial number in the projector’s memory. You can also choose a lamp mode for regulating power and light output, change optical aperture size, and access other read-only information pertaining to past and present lamps.

LAMP HOURS (read-only) shows the number of hours logged on the current lamp.

Whenever you record a new lamp serial number this value automatically resets to “0”, where it begins to log time for the new lamp. This information also appears in the *Status* menu.

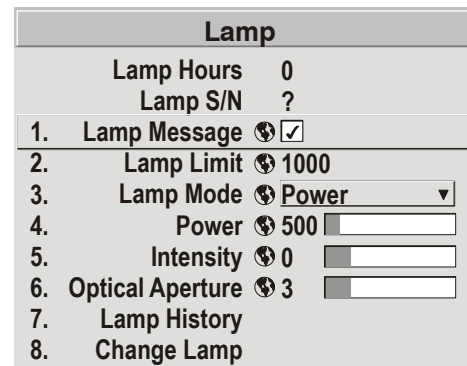

LAMP S/N (read-only) is the serial number recorded for the current lamp. When you install a new lamp and enter its serial number, the number will appear here.

Enter a checkmark for **LAMP MESSAGE** to enable a warning message that will appear upon power-up when the lamp has reached the specified lamp limit and should be replaced. Delete the checkmark to prevent display of this message—instead, when your lamp expires, only the status display messages on the back of the projector will provide the visual warning to replace the lamp.

NOTES: 1) *It is recommended that the Lamp Message checkbox remain enabled. 2)* *When a lamp warning message appears, press  to temporarily cancel the message. The message will continue to appear upon power-up until you install a new lamp.*

Set **LAMP LIMIT** to the number of hours you expect to log on the current lamp before replacing it. This will trigger a lamp message on-screen (if enabled).

NOTES: 1) If you change modes over the life of a lamp, the lamp limit you originally expected may no longer be possible. **2)** Turning the lamp on and off reduces lamp life significantly, as do other factors. **3)** It is recommended that Lamp Limit not exceed the expected lamp life, otherwise a lamp could become dangerously fragile with overuse.

Set which **LAMP MODE** you want to use in order to control the light output. You can choose to run the lamp as bright as possible (i.e., always using maximum power—this is the default upon power up) or you can power the lamp with a specific wattage appropriate for the installed lamp or you can set a specific intensity (brightness) to maintain. Although there are exceptions, generally higher light output or higher power settings can shorten lamp life.



Use the lamp mode that best suits your brightness needs. For example, in a tiled application you may want to precisely match brightness levels between adjacent images—judge by eye and set each individual **Lamp Power** setting as necessary. Or if you want images to be as bright as possible—choose **Max Brightness**. Always keep in mind that higher lamp power settings can shorten lamp life.

Lamp modes are described below:

- **Max Brightness:** The lamp will always burn as brightly as possible, driven by 100% of the power level rating for the installed lamp (see **Section 6, Specifications**). Keep in mind that the “maximum brightness” for any lamp gradually diminishes with age—images will become dimmer over time. Its current output level appears in the “**Intensity**” option (*not* in lumens).
- **Intensity:** Brightness will remain close to a specified level for as long as possible. Once you select this option, enter a number representing the intensity level (brightness) you wish to maintain—the projector will automatically adjust power as needed to maintain this intensity as closely as possible. Note that the intensity value is a correlation only and does not represent an actual lumens level. See “**Intensity**” below.
- **Power:** The power supplied to the lamp will remain at your specified wattage level. Once you select this option, enter the number of watts representing the power level you wish to maintain. See “**Power**” below.

POWER - This slide bar and number indicates how many watts are applied to the lamp. You can apply anywhere from approximately 60-65% of the maximum power intended for the installed lamp up to 100% of the lamp rating. Set for the number of watts as desired, keeping in mind that lower power levels produce dimmer images. When in either **Power** or **Max Brightness** modes, the power level remains constant. Specifying a maximum power level here is the same as operating in **Max Brightness** mode.

Power 941 

NOTE: *Power level can be set only if the lamp is in **Power** mode.*

INTENSITY - This value and slide bar represents the current brightness of your lamp, decreasing over time when you are operating in **Max Brightness** mode or at a specific **Power** level. When you are operating in “**Intensity**” mode this value remains at the original “**Intensity**” setting chosen and cannot be adjusted.

Intensity 1246 

NOTE: *The number shown for “intensity” is not the actual lumen output, but rather a correlated value only—1246 may represent 3500 lumens, for example.*

To use “**Intensity**” mode, judge by eye (or use a meter) and set the level as desired for your application. Over time, the projector will automatically increase the power supplied to the lamp as needed to maintain the chosen intensity as closely as possible. This mode is known as “Brightness Tracking” or “LiteLOC™”.

HOW LONG CAN I MAINTAIN BRIGHTNESS? Software can maintain your “**Intensity**” setting until the required power reaches the maximum rating for the lamp. The lower the setting, the longer it will take to reach this threshold and the longer you can maintain the desired brightness. Keep in mind that once the lamp power reaches its *maximum* wattage (see “**Power**”, above), this tracking is no longer possible. At this point, the lamp will gradually begin to dim as usual, even though your original “**Intensity**” value will still appear in the menu. To resume accurate tracking, reduce the intensity setting so that the resulting “**Power**” value is less than its maximum—the lower the intensity, the longer it can be maintained.

For example, a 1000-watt lamp can be driven at no more than 1000 watts. To produce desired brightness at the screen, a new lamp would likely need less than this maximum rating—perhaps 812 watts (example only). Over time, however, the lamp will require more and more current in order to generate the desired light, until eventually the lamp wattage reaches its 1000-watt maximum and the lamp power automatically levels off. At this point, the tracking function terminates (i.e., the power level stabilizes) and the lamp will begin to dim normally. Either reduce your “**Intensity**” setting or replace the lamp.

Do not lower the “**Intensity**” so much that the corresponding “**Power**” value reaches its *minimum*—the intensity setting will be inaccurate and cannot be maintained. For best results in achieving uniform intensity amongst tiled images, choose an “**Intensity**” setting that enables all lamps to operate at less than the maximum number of watts available in your projector but high enough to keep the corresponding lamp power above its minimum. See “**Power**”, above.

NOTES: **1)** *Lamps become more stable over time, thus a specific intensity is more easily maintained as the lamp ages.* **2)** *Intensity can be set only if the lamp is in “Intensity” mode* **3)** *Intensity cannot exceed the output of Max Brightness mode.*

OPTICAL APERTURE - This option is also available under the *Advanced Image Settings* menu. See 4.6 – *Adjusting the Image* for details.

LAMP HISTORY - This read-only option lists the lamps most recently installed and recorded in the projector. *Lamp History* automatically updates whenever you record a new lamp serial number—the new lamp is added to the bottom of the list.

Lamp History	
S/N	Hours
1234	1999
5678	27

Use **CHANGE LAMP** to record the serial number for a newly installed lamp:

In the *Lamp S/N* window, use the number text entry keys to record the new lamp serial number and press  again to accept the change. See *Using Slide bars and Other Controls* if you need help entering the number. Once entered, the new lamp serial number will be added to the *Lamp History* menu and the *Lamp Hours* timer will reset to “0”. *Lamp Mode* and *Lamp Limit* remain as they were for the previous lamp and can be changed at any time. See Figure 3.13.

NOTE: To scroll through letters/alpha numerics, refer to 3.4 *Navigating the Menus, Edit Numerical Values*.

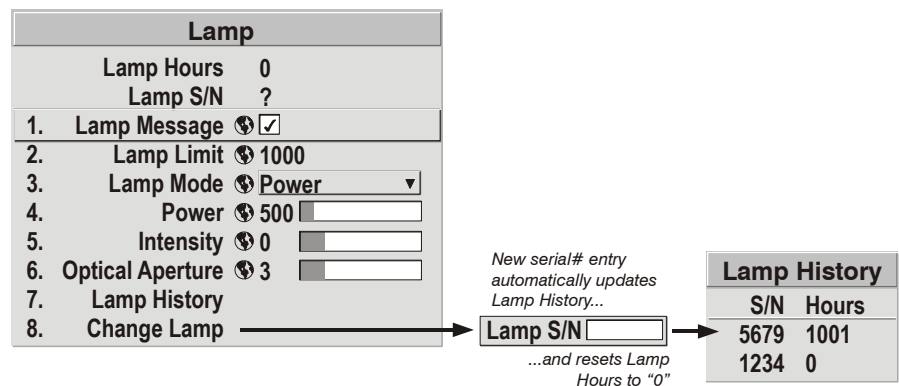

Figure 3.13. Recording the New Lamp Serial Number

NOTE: Enter a serial number *only* if you have just installed a new lamp. This will help ensure that lamp timer is not reset on an old lamp and that the number of hours logged on the lamp will be accurate.



IMPORTANT

ALWAYS record the serial number of a **NEW** lamp.

How Old is My Lamp? ► When a new lamp is installed and its serial number recorded by selecting “Change Lamp” in the *Lamp* menu, the lamp timer resets to “0” and begins logging time for the new lamp. This tally appears in both the *Lamp* menu (see right) and the *Status* menu.

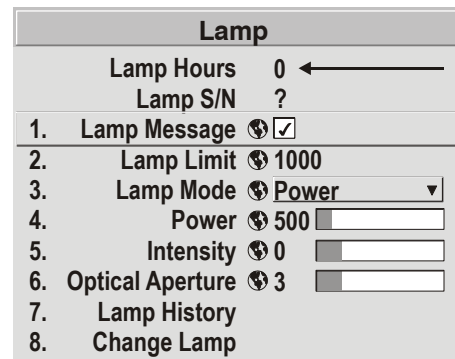

To review the number of hours logged for previous lamps, consult the *Lamp History* menu.

When to Replace the Lamp ► If the “Lamp Message” checkbox has been enabled in the *Lamp* menu (recommended), an expiry message will appear upon power-up when the lamp has reached its defined “Lamp Limit”. In addition, the LED’s next to the built-in keypad will flash “LP” when lamp time has expired. The lamp should be replaced.

The “Lamp Limit” setting should not exceed the expected lamp life, as an old lamp becomes increasingly fragile and more prone to sudden failure. See also **4.4, Lamp and Filter Replacement**.

3.9 Status Menu

The read-only *Status* menu lists a variety of details about the standard and optional components currently detected in the projector. Refer to the *Status* menu for versions of hardware and software installed, the type (size) of lamp, the hours logged in total and for a specific period (such as a rental period), and for your projector model name and serial number. In addition, the *Status* menu identifies the current channel, its location, its frequencies and other details.

Scroll the full *Status* menu using . Use for page up/down.

3.10 Using Multiple Projectors

IMPORTANT: When working with more than two projectors, it’s important to work left to right, top to bottom.

When an installation requires multiple projectors, you can use the RS232 serial ports to daisy chain the units together and control the group with a single keypad or a computer/controller connected to the first projector. In such a network, you can choose to broadcast commands to the entire group, or use the **[Proj]** key as desired to limit responses to an individual projector.

Alternatively, you may want to add projectors to a hub on an Ethernet network. See **2.4, Connecting Communications** for full routing details.

NOTE: Refer back to **3.6, Adjusting System Parameters and Advanced Controls** for complete information about communicating with multiple projectors.

Matching Colors In Multiple Screens ► In a multiple-projector wall, you will likely want to precisely match color and intensity from image-to-image so that the full wall is as uniform as possible. This matching is typically done in conjunction with brightness uniformity and edge blending.

Preliminary Calibration

As a final part of the manufacturing process, all primary colors in the projector are precisely set to pre-established values to ensure that overall color performance is optimized and is as accurate as possible. Upon installation at a site, however, lighting and other environmental factors may slightly change how these colors appear on your screen. While the change is negligible in most cases, you may prefer to recover the originally intended color performance before trying to match colors from several projectors. Or you may be renting a projector in which the colors were corrected for use at its previous site, but are not ideal for yours.

The recommended first step in achieving such consistency is to use a color meter to measure the native primary colors—red, green, blue, and white—as they appear at the screen and record these as *Color Primary Settings* in the *Service* menu (password-protected) for each projector. On the basis of these new values, which are stored in memory, each projector will then automatically calculate any necessary corrections to reproduce the original factory colors under the current environmental conditions. This essentially calibrates a projector to its surroundings, compensating for factors such as screen type; lamp and/or ambient lighting that can alter the final color characteristics on-screen, and will improve color accuracy and consistency in a group of projectors. It ensures a good starting point for further customizing and matching; however, is not critical for all installations.

To return to the factory-set color primaries, such as when a projector is moved to different site, you must access the *Service* menu (password-protected). Select the “*Reset to Factory Defaults?*” option in the *Color Primaries* submenu. Then repeat the calibration process describe above, if desired, and continue with matching of colors.

Color Adjustment Procedure

Once the *Color Primary Settings* are calibrated for the site (see above), use the *Color Adjustments by X,Y* or *Color Saturation* menu to further refine each projector’s fundamental colors so that the hue and intensity of each color appears the same from one display to another. Once matched, you will have created a single new shared range of colors or “color gamut” that all of your projectors can produce. This palette—named User 1, 2, 3 or 4—can be applied or disabled for a source at any time throughout a bank of adjacent displays, simplifying both the setup and maintenance of a “seamless” wall.

1. Set up and optimize all projector settings. You can ignore color temperature, since you will be redefining color performance in this procedure, but do optimize each projector in every other aspect. Closely align all screen edges.
2. Assign projector numbers to make communications easier. Use desired keypad.
3. Use the same lamp mode for all projectors, and do the following:
 - Set *Select Color Adjustment* to “Max Drives”
 - Display a full white test pattern
 - Adjust lamp power and Optical Aperture until adjacent white fields appear the same brightness.

4. Display the *Color Adjustments by X,Y* menus for all projectors. Each menu shows the x/y coordinates defining the “Max Drives” color gamut for this projector. Note the values shown in one (any) of the displays. See Figure 3.14. Or use the “Copy From” function to copy them into a “User” gamut in one projector.

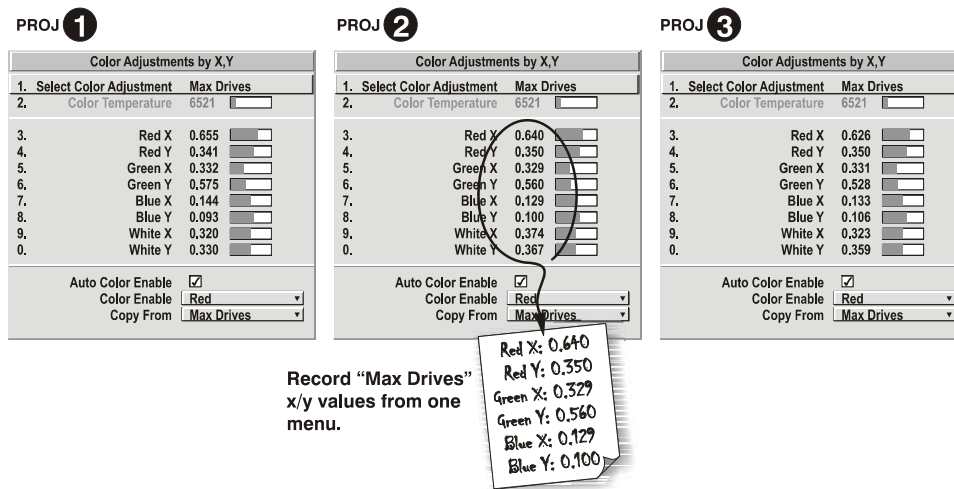

Figure 3.14. Jot Down a Set of “Max Drives” X/Y Values

5. In each projector, select a “User” color adjustment (1-4) to enable *Color Adjustments by X,Y* changes. Then enter your recorded x/y values into each menu (Figure 3.15).

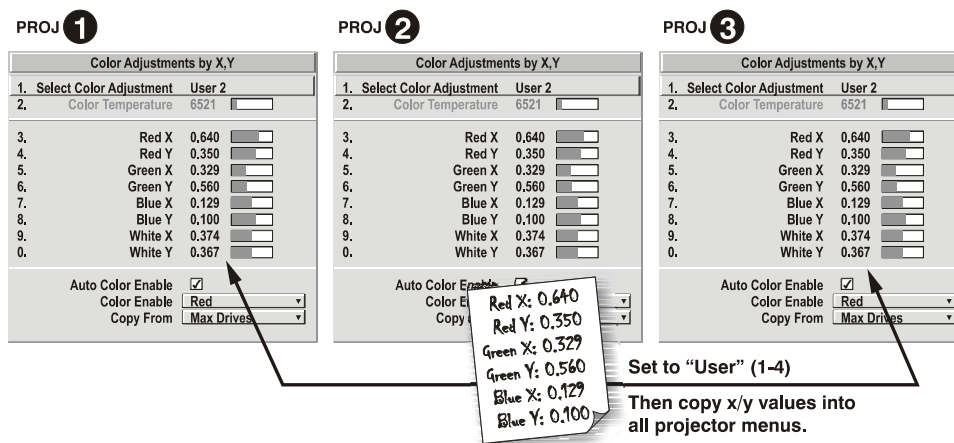
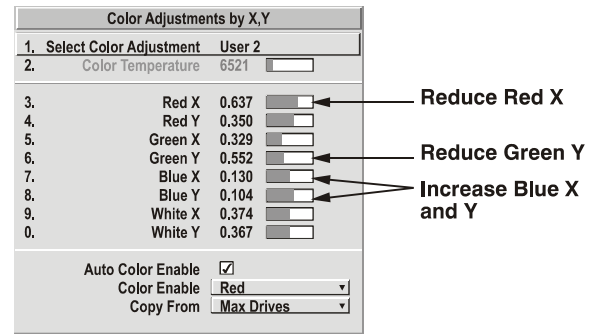

Figure 3.15. Copy X/Y Values into All Projectors

6. In each projector, judge by eye and adjust x/y coordinates slightly in the following manner:

- To match reds, decrease “Red X” until full field red screens match.
- To match greens, decrease “Green Y” until full field green screens match.
- To match blues, increase both “Blue X” and “Blue Y” until full field blue screens match.

IN ALL PROJECTORS:



NOTE: For speed, enable the “Auto Color Enable” checkbox. Each color coordinate you select will then automatically trigger a full field display of the corresponding color.

Alternatively, use the Color Saturation menu for these adjustments or to fine tune.

NOTE: For speed, enable the “Auto Color Enable” checkbox. Each color coordinate you select will then automatically trigger a full field display of the corresponding color.

These coordinate adjustments move the three color points closer together (see below) to establish a “shared” gamut attainable by all projectors in your group. Adjust only as necessary to ensure that the resulting color palette is as large as possible. When done, you may need to adjust lamp power slightly.

7. All screens should now be color-matched. Apply this new “User” gamut to a source at any time by selecting it in the “Select Color Adjustment” list accessed in the *Advanced Image Settings* menu.

Using the Color Saturation Menu for Color Matching

You may prefer to use the *Color Saturation* menu to match colors across multiple screens. In the three *Color Adjustment* submenus (Red, Green, Blue—see right), set all main values to 100 and the secondary values to 0. Then judge by eye and adjust the slide bars as needed. Note that adjustments here define new x/y coordinates in the *Color Adjustments by X,Y* menu.

For best results, use this menu after doing the color adjustment procedure.

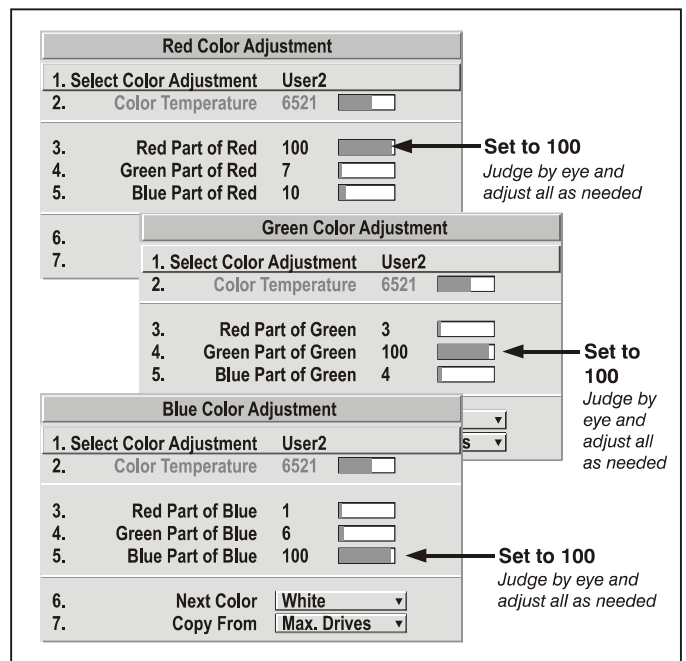

Figure 3.16. Color Matching Using Color Saturation Menu

Achieving Brightness Uniformity

▶ **WHAT IS BRIGHTNESS UNIFORMITY?** When used to refine screens already matched for their primary colors (see *Matching Colors in Multiple Screens*, above) and overall light output, proper adjustment of *Brightness Uniformity* can create an exceptionally smooth screen in which:

- No area of the screen appears more red, green or blue than another
- No area of the screen appears brighter than another
- Color and light output from one screen closely matches adjacent screens

Although the *Brightness Uniformity* control can be used for a stand-alone projector, it is particularly useful for setting up and maintaining tiled images that form a cohesive display wall in which the color “cast” and light output appear uniform throughout each image as well as throughout the entire wall. The procedure provided here assumes a multiple-screen application.

Before You Begin

Read through the entire procedure before attempting to adjust Brightness Uniformity controls, and keep in mind the following checklist of prerequisites and guidelines:

- ❑ **ADJUST COLORS FIRST**—Always adjust the primary colors as described in the “*Matching Colors in Multiple Screens*” procedure (above) before attempting to work with Brightness Uniformity. This ensures that primary colors, color temperature, and maximized light output are all well matched from one screen to another. These matches are needed before you can achieve good Brightness Uniformity results.
- ❑ **RUN LAMP FOR 100 HOURS**—Light output and Brightness Uniformity can vary significantly during the first 100 hours of lamp use. For best results with new lamps, either set up Brightness Uniformity after this period, or do an initial setup and re-check at 100 hours.
- ❑ **SET LAMP POWER**—Ensure that each “Lamp Power” setting is as high as possible for your application while still maintaining a good overall match of light output from screen-to-screen. By nature, achieving a *uniform* brightness will require a slightly reduced *overall* brightness—this reduction will help ensure that you have enough range of adjustment when examining brightness variables more closely from screen-to-screen, and will help prevent premature “maxing out” when trying to match to a certain color, zone or projector.
- ❑ **USE A “USER” COLOR TEMPERATURE**—Always adjust Brightness Uniformity for a *User* color temperature defined when you matched primary colors, and continue to use it for all sources displayed on the wall. Your other color temperatures will not necessarily be matched from screen-to-screen.
- ❑ **WHITE UNIFORMITY SLIDE BARS**—White Uniformity slide bar values may not reduce to “0”. Each slide bar adjusts overall light output in a specific screen zone, but the value shown represents the current setting for *green* in this zone. When other “hidden” values (red or blue) are lower than green, during adjustment in the White Uniformity menu their values will reach “0” first, causing the slide bar to stop earlier than expected.
- ❑ **JUDGE BY EYE OR USE A METER**—Good brightness uniformity can be achieved with either.

Step 1: General Setup

- 1a) Adjust primary colors (see *Matching Colors in Multiple Screens*) to ensure matched overall color temperatures and light output between screens.



IMPORTANT

Double-check that all WHITES and LIGHT OUTPUT are well-matched.

- 1b) Enable the *Brightness Uniformity* checkbox. This will enable access to the uniformity controls and will apply the settings to your image.

Brightness Uniformity	
1.	Uniformity Enable <input checked="" type="checkbox"/>
2.	Test Pattern <input type="text" value="Off"/>
3.	Left Uniformity
4.	Right Uniformity
5.	Top Uniformity
6.	Bottom Uniformity
7.	White Uniformity
8.	Color Adjustment by X,Y
9.	Color Saturation
0.	Lamp

← Enable adjustment of options #3-7

- 1c) Select the 13-Point test pattern for display. This pattern provides nine screen “zones” with 13 targets.

FOR BEST RESULTS: Rather than examining the CENTER of each zone when assessing Brightness Uniformity adjustments focus on extreme EDGES as indicated in the illustration at right.

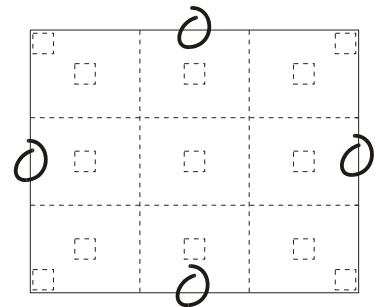

- 1d) In either *Color Adjustments* menu, select a “User” color. Then:

- *If you have created a “User 1” color gamut* (recommended) for a well-matched wall, continue to Step 1e.
- *If you prefer maximum brightness* rather than a particular color temperature, select “Max Drives”.

IMPORTANT: Do not change User 1 Color Adjustment in color-matched applications!

- 1e) In the *White Uniformity* menu, set the “Overall” output level to **50.0** and all remaining slide bars to **0.0**. This decreases the light output *just enough* throughout the screen so that any color level can then be *increased* later as necessary for matching light output from zone-to-zone. Do not exceed **50.0** for “Overall”—a higher level will likely interfere with achieving brightness uniformity and is not recommended.

White Uniformity		
1.	Left Side	0.0 <input type="text"/>
2.	Right Side	0.0 <input type="text"/>
3.	Top Edge	0.0 <input type="text"/>
4.	Bottom Edge	0.0 <input type="text"/>
5.	Top Left Corner	0.0 <input type="text"/>
6.	Top Right Corner	0.0 <input type="text"/>
7.	Bottom Left Corner	0.0 <input type="text"/>
8.	Bottom Right Corner	0.0 <input type="text"/>
9.	Overall	50.0 <input type="text"/>
Adjust light output of entire screen.		

← Set to 50.0

Ensure that overall light output remains well matched from one screen center to the next. Where necessary, increase or decrease Lamp Power slightly to recover center matches.

Step 2: Adjust Color (level of red/green/blue) in Eight Zones

NOTES: 1) At this point, ignore the **brightness** of individual zones. **2)** Always ignore menu colors.

- 2a) On each screen, compare the color temperatures in the eight target zones (four edges and four corners) to that of the color temperature of the center. Compare using a **white** field only, and take note of any areas that do not match the center. Also decide if any screen exhibits a more obvious color shift than other screens—begin with this screen in Step 2b.
- 2b) Return to the *Brightness Uniformity* menu. Beginning with the screen that exhibits the most obvious color shift(s), for each edge that exhibits a noticeably different color temperature from the center, select the corresponding *Uniformity* adjustment menu—*Left, Right, Top* or *Bottom*. For example, if any part of the left side is too blue, too red or too green, go to the *Left Uniformity* menu and adjust the colors (i.e., change their light output) until all portions of the left side closely match the center color temperature. Adjust an edge first (focusing on its center), and then adjust its corners. See Figure 3.17.

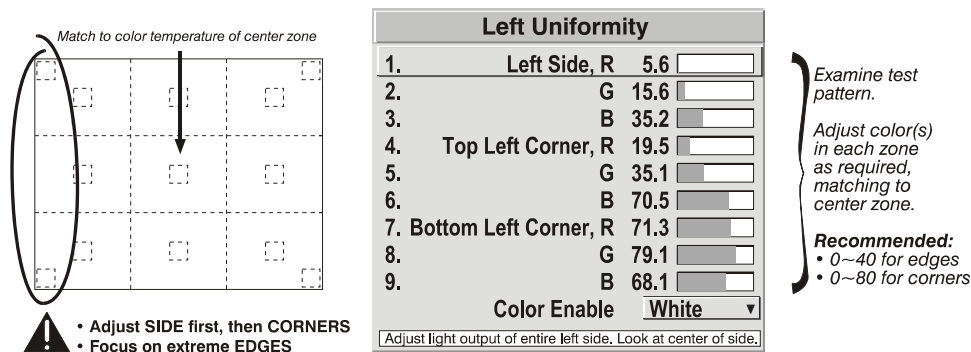

Figure 3.17. Match Zones to Center Color Temperature

Repeat the color adjustment of sides and corners for each edge of the screen that does not yet match the center (note that each corner is adjustable in either of its two adjacent “side” menus). When done, all areas of a given screen should match. Repeat Steps 2a & 2b for all remaining screens.

Step 3: Adjust Light Output in Eight Zones

- 3a) For each screen, compare the light output of each *edge* and *corner* to that of the *center*. If any of the areas differ, use the *White Uniformity* menu to match edges and corners to the center as described below (see Figure 3.18). Begin with the screen exhibiting the most obvious variations in light output.
 - Adjust **edge White Uniformity** first—note that each edge adjustment also affects the rest of the screen slightly. Keep all edges just slightly *lower* than the center light output rather than matching light output precisely. Otherwise, it may not be possible to brighten the corners (typically the dimmest areas of the screen) enough. I.e., the best uniformity is a compromise between the brightest and darkest areas of the screen.

- Adjust **corner White Uniformity** last—each corner adjustment affects only this quadrant.
- Repeat for each screen.

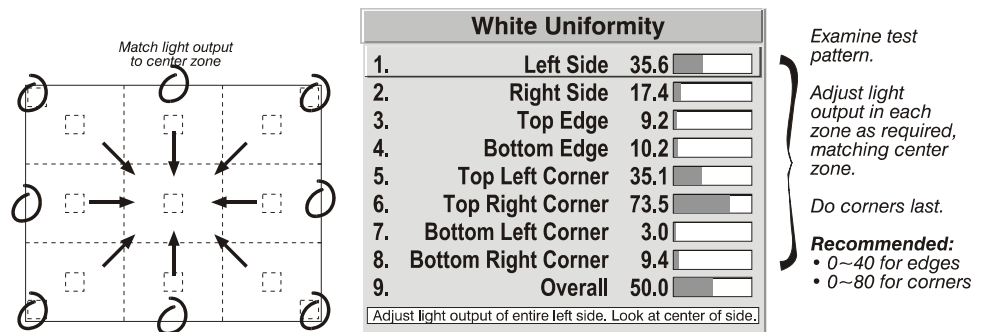

Figure 3.18. Match Zones to Center Light Output

Step 4: Readjust Color Temperature (level of red/green/blue) in Eight Zones

4a) Return to Steps 2a & 2b and, if necessary, fine-tune the zones so that they all still exhibit a single color temperature.

Cancelling Brightness Uniformity

If you do not want to use or apply Brightness Uniformity settings, delete the checkmark from the “Uniformity Enable” checkbox at the top of the *Brightness Uniformity* menu.

Edge Blending ► Christie *Edge Blending* is an innovative set of software functions that can quickly and easily blend white levels along the edges of multiple adjacent projected images to create a single seamless larger image.

What is a Blend?

In simple terms, a blend appears as a gradient strip along an edge of a projected image. It is darkest along the extreme edge of the image, and lightens nearer to the rest of the image (see right).

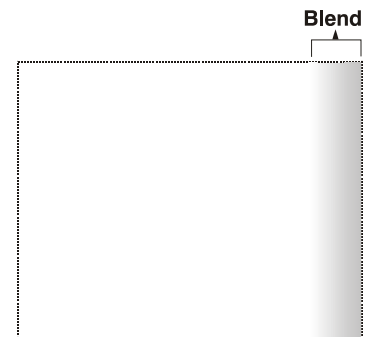

How Are Blends Used?

In multiple-projector walls, complementary blends between neighboring images can compensate for the extra “brightness” or intensity where these edges overlap. By controlling blend width and other properties, you can achieve uniformity across the group of images. Visible overlaps will disappear:

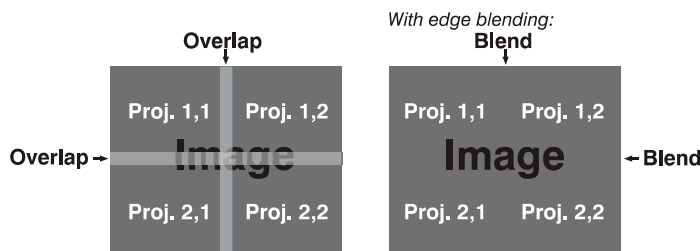

Figure 3.19. Edge Blending Concept

For best results, use the same projector model and type throughout your display wall. In addition, avoid high-gain screens whenever possible—the optical performance of such screens demands minimal image offset, thus projectors must be located very close to one another.

Edge blending software controls are located in the two-page *Edge Blending* submenu—access via *Configuration* menu, then go to the *Geometry and Color* menu and select *Edge Blending*. The *More* option opens the second page of the *Edge Blending* submenu.

Main Functions

Use Edge Blending controls to set the precise *width*, *shape* and *midpoint* you need to blend overlapping edges together smoothly.

- **Blend Width** determines how much area is used for blending along an overlapping edge. Slide bar values represent the number of eight-pixel steps used for the blend. For example, a setting of “eight” creates a blended edge 24 pixels wide. A setting of “0” signifies no blending. For best results in most applications, use a blend width of 16-48 steps (128-384 pixels).

Ranges: 0-80 horizontal, 0-60 vertical.

- **Blend Shape** determines the rate of roll-off across the blend width, i.e. how quickly the white levels across the blend change from light and dark. Increasing the *Blend Shape* setting accelerates the rate of change at both extremes so that *less* of the region appears mid-gray (see Figure 3.20). Decreasing the *Blend Shape* setting slows the rate of change so that *more* of the region appears mid-gray. For most applications, this subtle control is best left close to 50.

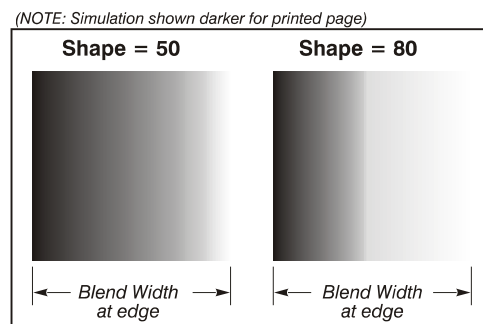

Figure 3.20. “Shape” Examples

- Blend Midpoint** determines the white level at the blend midpoint (the point equidistant between the beginning and end of the blend). Increasing the *Blend Midpoint* setting creates a blend that appears brighter than the rest of the image. Decreasing the *Blend Midpoint* setting creates a blend that is darker than the rest of the image. A setting of 50 means the midpoint is approximately 50% black—for best results in most applications, keep fairly close to this default.

(NOTE: Simulation shown darker for printed page)

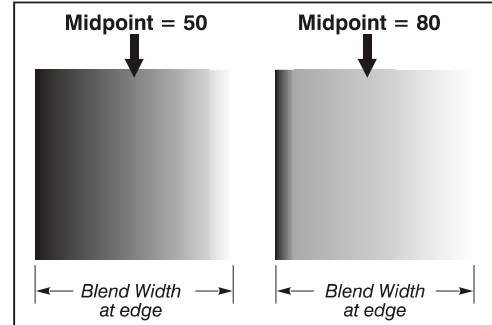

Figure 3.21. “Midpoint” Examples

- Show Blending Overlap** turns your defined blend width area to solid gray so that, if needed, simply overlapping the gray bars can seamlessly align two adjacent images. Toggle the *Show Blending Overlap* off to reactivate the blend effect.

NOTE: *Blending Overlap* appears as *Reserved* when Christie TWIST is installed.

Other Functions

For convenience, the *Edge Blending* submenu also includes related options for enabling a specific color and/or test pattern, or for working with colors or the lamp. Such functions duplicate those provided elsewhere in the menu system.

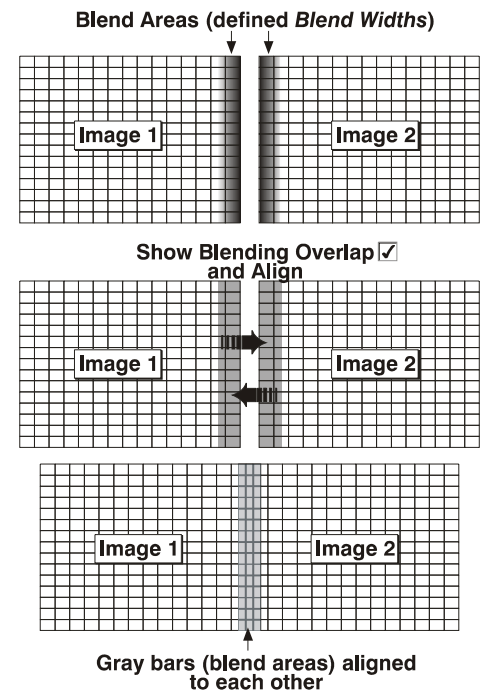

Edge Blending Procedure

NOTE: Before attempting to work with edge blending software functions, you must **1)** physically align the projectors/images by correctly overlapping the displays from your intended external source, and **2)** Match colors and Brightness Uniformity.

IMPORTANT: For a shared edge, all *Blend* procedures and settings should be identical on BOTH projectors.

- Start with two projectors. Display full white field test pattern from both.
- In the *Edge Blending* submenu, enable *Edge Blending* by entering a checkmark in the top checkbox.
- SET STARTING POINTS FOR ADJUSTMENT:**
 - Set all blend widths to 0.
 - Go to “More” and set everything in the *Edge Blending (2)* menu to 50.

Edge Blending		Edge Blending (2)	
1.	Blending Enable <input checked="" type="checkbox"/>	1.	Left Blend Shape 50 <input type="text"/>
2.	Test pattern Off	2.	Left Blend Midpoint 50 <input type="text"/>
3.	Left Blend Width 0 <input type="text"/>	3.	Right Blend Shape 50 <input type="text"/>
4.	Right Blend Width 0 <input type="text"/>	4.	Right Blend Midpoint 50 <input type="text"/>
5.	Top Blend Width 0 <input type="text"/>	5.	Top Blend Shape 50 <input type="text"/>
6.	Bottom Blend Width 0 <input type="text"/>	6.	Top Blend Midpoint 50 <input type="text"/>
7.	Color Enable White	7.	Bottom Blend Shape 50 <input type="text"/>
8.	Lamp	8.	Bottom Blend Midpoint 50 <input type="text"/>
9.	Show Blending Overlap <input checked="" type="checkbox"/>	9.	Color Enable 50 <input type="text"/>
0.	More	Adjust shape of blend curve on the left side. Refer to instructions.	
Use or disable Edge Blending. Refer to Help and Manual.			

Figure 3.22. Set Starting Points for Each Projector

4. **SET BLEND WIDTH:** On one projector, increase the *Blend Width* for an overlapping edge (for example, if the projector's image is on left, its right edge overlaps the adjacent image—adjust *Right Blend Width*). Use the same setting on the second projector for this shared edge.
5. Re-adjust width (both projectors) until the overly bright band at the midpoint of the overlapping blends disappears or *just* changes to very light gray. For the shared edge, use the same *Blend Width* setting on each projector. If the “best blend” appears to be between two settings, choose the wider setting for both projectors.
6. **CHECK BLEND:** If the blended region appears too dark or light in relation to the rest of the image:
 - Increase *Blend Midpoint* in both projectors to “lighten” the overall blend, decrease to “darken” the overall blend.
 - Adjust *Blend Shape* in both projectors to fine-tune change the amount of mid-gray intensity (as opposed to black/white) in the blend.
7. Repeat with remaining projectors / overlaps.
8. Check completed display wall with the desired external signal.
9. Adjust mechanical alignment if necessary to maintain perfect pixel-on-pixel alignment over time.

In applications where you are projecting only white or light images, the *Blend Width* may be slightly higher—set according to how much overlap you have between images. Use the following as a guide (examples show overlapping width only—values for overlapping height will differ):

- Recommended overlap is 12.5% - 25%

Black Level Blending ►

Similar to Edge Blending, Black Level Blending allows you to adjust the black level hues of multiple adjacent projected images to create one large seamless display. Edge blending must be enabled in order to use the Black Level Blending features.

The use of Black Level Blending feature and the use of Christie TWIST module are mutually exclusive. On WU models, Keystone is only available when Christie TWIST is in use. If Christie TWIST is installed and Black Level Blending is desired:

1. Disable use of warps or 2D Keystone.
2. Enable edge blending; if not enabled.
3. Enable Black Level Blending.
4. Power down the projector then power up again.

Adjustments can now be made to black level controls.

To restore the use of Christie TWIST:

1. Disable black blending.
2. Power cycle the projector.
3. Begin using the TWIST controls.

Black Level Blending Procedure

NOTES: 1) Adjust white levels before adjusting black levels. **2)** The zones in BLB menu correspond to the Edge Blend zones. If a given Edge Blend zone width is set to 0 (i.e. no blend on that side) then the corresponding BLB zone is disabled. It only becomes accessible when that Edge Blend zone is active.

1. Start with two projectors. Select the black test pattern for both projectors from the *Geometry and Color* submenu.
2. In the *Black Level Blending* submenu, enable black blending by putting a checkmark in the checkbox for each projector.

Black Level Blending			
1.	Black Blending Enable		<input checked="" type="checkbox"/>
2.	Center Brightness		0
3.	Black Red Level		128
4.	Black Green Level		128
5.	Black Blue Level		128
6.	Top		
7.	Bottom		
8.	Left		
9.	Right		

3. Working with one projector at a time, use the center brightness slide bar to adjust the center brightness (brightness of the non-blended region) so that the center intensity matches that of the brightest blended region (the center of all images when blending a 2 x 2 display is the target area).
4. Use the following three color slide bars, Black Red Level, Black Green Level and Black Blue Level, so the black hue of each projector matches.
5. You can choose which of the next four options, Top, Bottom, Left, Right, to use depending on which edge of the projector you are working with has been edge blended. The blend width can be adjusted to line up properly but by default it corresponds to the edge blending setting determined for that edge.

Top			
1.	Top Brightness		123
2.	Top Left Brightness		0
3.	Top Right Brightness		0
4.	Top Width		117
5.	Black Red Level		128
6.	Black Green Level		128
7.	Black Blue Level		128

Not applicable when blending two projectors (corresponds to sides selected in Edge Blending menu).

6. The brightness and black hues of the blended region can be adjusted in more detail in case fine-tuning is needed (may be only necessary for blending a 2 x 2 projector display because of blending differs for the sides and center).

NOTES: **1)** *The menu options vary depending on the Edge Blending parameters.* **2)** *You may need to re-adjust the black level hues following the overlap adjustments on each blended edge.* **3)** *When adjusting six or more projectors, you need to ensure that the hue and brightness of each target area is matched as closely as possible.*

3.11 Remote Control of the Projector

As an alternative to using a keypad, most projector functions can be controlled remotely, typically at a controller such as a PC, via 1) simple bi-directional ASCII messaging on an Ethernet or serial communication link or 2) a web interface or “ChristieNET” on an Ethernet network. Using a PC interface can also prove to be useful in instances where extreme warping is applied and the menu items become illegible and hard to navigate.

VIA ASCII MESSAGING — Connect a serial link between your controller and the RS232 or RS422 port (recommended), or open an Ethernet socket (i.e., Telnet) between your controller and the valid projector address. Valid ASCII codes and messages are documented in the *Christie Serial Communications* document available at the Christie website.

VIA WEB INTERFACE — Connect your PC to the projector’s Ethernet port. In your web browser (*Internet Explorer*, for example), enter the IP address of the projector you wish to control. This will start a password-protected ChristieNET application—enter the factory default “**ccm7**” login and password to open the program. If the projector is powered up, you can access assorted menu options and slide bars.

Repeat for remaining networked projectors as desired. Keep in mind that multiple units can be controlled from one PC, but each unit will be in its own ChristieNET interface (web browser) at the PC. Likewise, you can make up to five separate web locations to a single projector.

The default login provides access to security settings, where you can define other users with the same or fewer rights. Use “unlimited” rights for most applications. For all logins, the *Service* menu is still protected with its own password.

NOTES: **1)** *Any proxy server settings that interfere with this type of link should be disabled for using ChristieNET. Disable through Internet Explorer’s < Tools> <Internet Options> <Connections> <LAN Settings>.* **2)** *Your PC must be Java-enabled to v1.4.2 or higher to run ChristieNET.* **3)** *Depending on your projector model, certain controls provided through ChristieNET are non-functional.*

3.12 Error Conditions

Occasionally the projector will encounter an error condition that can interrupt normal operation. Such a condition can be caused by a simple invalid keypad entry, an input signal error (most common) or a system error. The manner in which users are to be notified of error conditions is set in the *Menu Preferences* menu:

- To see error messages displayed on-screen, select the “**Screen**” or “**All**” option.
- To be notified via a serial communication only, select the “**RS232**” option.
- To receive both types of notifications, select “**All**”.
- To disable error messages (except for “invalid user key entry”, which can’t be hidden), select “**Off**”.

Note that a two-digit error code appears in the status LED display window located beside the built-in keypad at the rear of the projector. Normal operation is indicated by the “0n” status code.

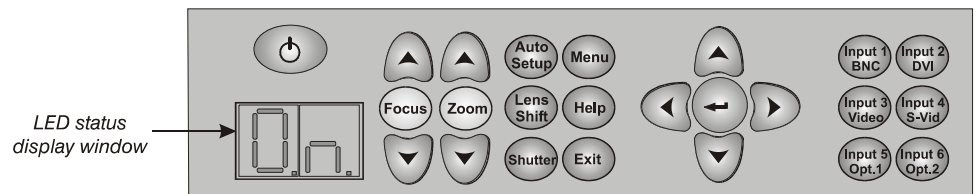

User Errors ▶ Invalid User Entry

A keypad entry not recognized by the projector triggers a short on-screen error message identifying the problem. For example, if you specify a channel number that is not available, the message “*Invalid Channel*” will appear. Or if you try to enter the wrong password, you’ll see “*Invalid Password*”. Press or to clear the message and try again.

NOTE: *On-screen display of “Invalid User Entry” messages cannot be disabled, even if **Display Error Messages** has been set to “Off”.*

Input Signal Errors ▶ An input signal error message occurs if you are in presentation level (i.e., there are no menus present) and have selected an input on which the projector detects a problem. While menus remain operational and any key press will temporarily remove any displayed error message, you must resolve the signal problem in order to permanently eliminate the message.

No Signal



The message “*No signal*” occurs when there is no source signal detected at the selected input—both HSYNC and VSYNC are inactive and the screen background is black. Connect or correct the signal, or try another input.

Bad Sync

The message “*Bad Sync*” occurs when HSYNC or VSYNC are active but the signal cannot be displayed. Such a condition occurs when only one of the two sync signals is present or when either sync signal is unstable or is the wrong frequency. Correct the signal or select another input.



Other Signal Error Messages

In addition to the common "Bad Sync" and "No Signal" errors, you may encounter a signal error message indicating that HSYNC and/or VSYNC are either too fast or too slow. When such a message appears, check the frequencies shown in the *Status* menu. If they are correct, the projector does not recognize the signal. On some PCs you may be able to change the settings to generate a compatible signal. If the frequencies shown in the *Status* menu are incorrect, check the cabling to see where the problem might originate.

- System Warnings / Errors** ► When the projector encounters a system malfunction, either a *System Warning* message or a *System Error* message may appear. Both types of messages are accompanied by a numerical error code on the status LED display. A system malfunction can be cleared with   from presentation level, but may indicate the need for service by a qualified service technician.

NOTE: *System messages appear on-screen only if Display Error Messages has been set to "Screen" or "All".*



System Warnings

A system *warning* indicates that a system malfunction has been detected (see *Status LED Codes*, below). A system warning message replaces any input signal message and disappears when the input signal status changes. While the projector will remain operational, the message indicates the presence of a potentially serious problem that should be investigated. You can press   to remove the message, but for best results you should reset the projector—power the projector down and up again with the  (power) key.

System Errors

A system *error* message indicates that a serious malfunction has been detected and must be investigated as soon as possible (see *Status LED Codes*, below). The projector will no longer operate and must be reset—power the projector down and up again with the  (power) key.



The Status LED Codes

If the status code display on the back of the projector shows one of the following values, you have encountered a likely system error requiring the attention of a qualified service technician (see *System Warnings* and *System Errors*, above). Acknowledge and clear the error with   from presentation level, or try resetting the projector by powering it off and on again, cooling when necessary. Consult **Table 3.5** and contact your dealer if the problem persists.

The specific code number identifies the source of the error detected, and is particularly useful in cases where the projector is far away. For example, the code "27" means the lamp could not be turned on. Error codes for this projector are listed in **Table 3.5** below.

Table 3.5 Error Codes

Code	Description
GENERAL	
12	Software bug. Contact dealer/factory.
13	CRC error in flash ROM. Download new software.
14	Engineering-only programming is complete. Call Christie, replace TIPM.
15	Attempting to download code without being in boot mode
16	Invalid interrupt. Power off/on. If it persists, contact dealer/factory.
17	User forced system to stay in boot mode
18	Jumper for programming boot not installed
1E	External 3D Input Sync missing. Refer to section 5 Troubleshoot.
1F	External 3D Input Sync is wrong. Refer to section 5 Troubleshoot.
LAMP FAILURES	
20	Lamp turned on unexpectedly (fault related to ballast)
21	Lamp airflow low, overheating imminent
23	Cannot read valid ballast ID
26	Lamp Interlock: lamp door open, lamp not installed
27	Can't turn lamp on
28	Lamp turned off unexpectedly
29	Lamp ballast overheated
POWER AND COOLING	
46	Red DMD heatsink overheated
47	Green DMD heatsink overheated
48	Blue DMD heatsink overheated
49	Prism overheated
4C	Projector shutdown due to critical error
C0	Lamp blower failure (lamp not turned on)
51	LVPS fan failed (Fan 1)
52	LVPS/ Red cooling fan failed (Fan 2)
53	DC lamp fan failed in 500W / 1kW models (Fan 3)
54	Red DMD heatsink fan failed on 1kW and 1.2kW models (Fan 4)
55	Green DMD heatsink fan failed on 1kW and 1.2kW models (Fan 5)
56	Blue DMD heatsink fan failed on 1kW and 1.2kW models (Fan 6)
57	TIPM fan failed (Fan 7)
58	TIPM fan failed (Fan 8)
TIPM (Image Processor)	
60	Boot code CRC failed
61	Unable to program DigMux PLD
62	Unable to program Control PLD
63	Unable to program Bubks PLD
64	Unrecognized ROM type
65	Write to flash ROM failed
66	TIPM failure
67	Downloaded code will not fit
68	Scaler communication problem
BUILT-IN KEYPAD	
70	Unable to access EEPROM on the built-in keypad
71	EEPROM memory re-initialization on the built-in keypad
PANEL DRIVER AND FORMATTER	
80	Unrecognized Panel Driver
81	Unable to program device on Panel Driver
82	TI flash download failure
83	TI flash download failure
84	TI flash download failure
85	TI-I2C write failure
86	One or more Formatters not responding — Probable Formatter s/w fault
87	Formatter reports RDRAM failure
88	Red modular Formatter communication failure
89	Green modular Formatter communication failure
8A	Blue modular Formatter communication failure
93	Modular formatter architecture error
94	Modular formatter DMD mismatch
95	Modular formatter sequence mismatch
MISCELLANEOUS	
A0	Unable to program the optional module
A1	Unable to power the optional module
A2	Unable to program the Dual Slot Backplane Module (DSBP)
A3	Unable to program the optional Post Processing Module (Warp module)

Clear system errors with  . If necessary, try resetting the projector by powering it off and on again (cooling if necessary). For detailed information, monitor the RS232 IN port. Contact dealer/factory if error persists. Codes omitted from this table should not appear in your projector.

Maintenance

4.1 Warnings and Safety Guidelines

The projector is an international regulatory agency approved product designed for safe and reliable operation. To assure complete safety at all times it is important to acknowledge the following precautions while operating the projector.



WARNING
Always power down the projector using appropriate procedure and disconnect all power sources before cleaning or servicing.



WARNING
Always remove the lens when shipping the projector.



WARNING
NEVER look directly into the projector lens.
The high brightness of this projector could cause permanent eye damage.



WARNING
For protection from ultraviolet radiation, keep all projector shielding intact during operation.

CAUTION

Qualified personnel should perform installation ONLY.



Labels and Markings ▶ Observe and follow all warnings and instructions marked on the projector.



The exclamation point within the equilateral triangle alerts the user to important operating and maintenance (servicing) instructions in the literature accompanying the projector.



The lightning flash and arrowhead symbol within the equilateral triangle alerts the user to uninsulated “dangerous voltage” within the projector’s enclosure that may be of sufficient magnitude to constitute a risk of electric shock.

Instructions ▶ Read all operating instructions prior to using the projector.

Projector Location ▶ Operate the projector in an environment, which meets the operating range specified in *Section 6 – Specifications*.

- Do not operate the projector close to water, such as near a swimming pool. Do not operate in extremely humid environments.
- Do not place the projector on an unstable cart, stand or table. A projector and cart combination should be used with care. Sudden stops, excessive force and uneven surfaces may cause the projector and cart combination to overturn.
- Only use Christie-approved ceiling mount fixture, if the projector is to be ceiling mounted.

Lamp ▶ **Lamp:** The projector uses a Cermax® Xenon lamp to deliver its high brightness. A lamp should be replaced when it has reached its end of life or if a noticeable change in brightness occurs. Keep track of the number of hours the lamp has been in use (*Lamp Menu*) and be aware of any changes to brightness. These indicators will help you effectively maintain operation of the projector.



⚠ WARNING ⚠

Wait approximately five minutes after powering down the projector to allow internal cooling fans to stop and for the lamp to cool sufficiently before removing.

Never attempt to remove the lamp housing directly after use. The lamp is under great pressure when hot and may explode, causing personal injury and/or property damage. Allow cooling completely.

⚠ WARNING ⚠

Use only lamps supplied by Christie. Use lamps of the correct wattage for your projector model when replacing.

Filter: Replace the filter when you replace the lamp or sooner if required. It is important the filter be replaced regularly to ensure sufficient airflow through the projector, otherwise it could cause the projector to overheat.

⚠ WARNING ⚠

Use only filters supplied by Christie.

Refer to *4.4 Lamp and Filter Replacement for instructions*.

Power Cord and Attachments

▶ **⚠** The North American rated line cord is provided with each projector. Ensure that you are using a line cord, socket and power plug that meets the appropriate local rating standards.

Use only the attachments and/or accessories recommended by Christie. Use of others may result in the risk of fire, shock or personal injury.

⚠ WARNING ⚠

Use only an AC power cord recommended by Christie. Do not attempt operation if the AC supply and cord are not within the specified voltage and power range.

- Do not set or rest items on the power cord. Place the projector in an area where the projector cord cannot be abused or damaged by persons walking on it or by objects rolling over it.
- Operate the projector at the specified voltage only. Do not overload power outlets and extension cords as this can result in fire or shock hazards.
- The projector is equipped with a three-wire plug having a third grounding pin. This is a safety feature – if you are unable to insert the plug into an outlet contact an electrician to have the outlet replaced. Do not defeat the safety purpose of this grounding-type plug.

Ventilation ► Slots and vents in the projector provide ventilation. Never block or cover these openings. This ensures reliable operation of the projector and prevents overheating.

- Do not place the projector over a radiator or heat register. The projector should not be placed in an enclosure unless proper ventilation is provided.
- Do not insert objects into the ventilation openings of the projector. They may touch dangerous voltages or short-out components resulting in a fire or shock hazard. Do not spill liquids of any kind into the projector. Should an accidental spill occur, immediately unplug the projector and have it serviced by a qualified service technician.

Servicing ► If any of the following conditions exist, immediately unplug the projector from the power outlet and ask a qualified service technician to look at it.

- The power cord has been damaged.
- The internal cooling fans do not turn on within two minutes when the projector is first powered up.
- Liquid has been spilled into the projector.
- The projector has been exposed to excessive moisture.
- The projector is not operating normally or its performance has significantly deteriorated in a short period of time.
- The projector has been dropped or the shipping case (if applicable) has been badly damaged.



Do not attempt to service the projector yourself. All servicing must be performed by Christie accredited service technicians.

Use replacement parts that are manufacturer-approved only. Use of any other part other than the ones specified by the manufacturer can result in fire, electric shock or risk of personal injury and irreparable equipment damage.

4.2 Cleaning and Maintenance Guide

Table 4.1. Maintenance Guide

Part Description	Frequency	Action
Lens	As required	Clean the lens only when absolutely necessary. A small amount of dust on the lens has very little effect on picture quality. To clean: Use a soft lint-free cloth without any chemicals. Use only a high-quality coated optics cleaning fluid, which can be purchased from most camera supply stores. Apply the coated optics fluid directly onto the lint-free cloth until moistened. Wipe in a single sweep across the surface of the lens. To avoid scratching the lens do not scrub or rub in a circular motion. Discard the cloth after every use. Do not use cleaning tools treated with Ether. Do not use cleaning solvents that contain ammonia. Use compressed air to remove any particles remaining on the lens.
Lamp	As required	CLEAN: Clean if absolutely necessary. Never touch the glass surface of the lamp. Fingerprints left on the glass will seriously degrade lamp performance or cause “hotspots” which can lead to an accumulation of intense heat in the touched area and cause the lamp to shatter. To clean: Wait until lamp is cool. Moisten a clean, lint-free cotton cloth with isopropyl alcohol and gently rub the surface of the glass in a circular motion until clean.
	1000 hrs or sooner if required	REPLACE: Refer to 4.4 Lamp and Filter Replacement procedure later in this section.
Filters	Whenever a lamp is replaced or sooner if required	REPLACE: Do not reuse old filters. Use the filter provided in the Christie Lamp and Filter Kit.
Covers (External)	As required	CLEAN: Clean dust from external covers using a clean, lint free cotton cloth as required. NOTE: Before cleaning the modules, it is recommended that you install the lens cap. This will keep dust particles from settling on the glass surface of the lens.



WARNING

Proper face shield and protective gloves are required if the lamp module is removed from the projector.

4.3 Replacing Remote Batteries

The IR Remote Keypad uses two AA size, 1.5V batteries (preferably alkaline). To install new batteries:

1) Open the battery compartment at the backside of the keypad by placing your thumb in the oval depression and sliding the cover out about ½ inch. See Figure 4.1. Remove the old batteries and properly discard. Wait a minute or two.

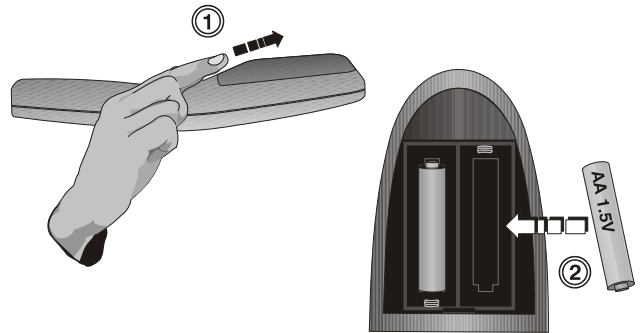

Figure 4.1. Replacing Batteries

2) Place the new batteries in the compartment, orienting the positive/negative of each battery according to the labels in the compartment. When the batteries are in place, replace the cover by placing the cover ½ inch from its closed position and slide it into place. Do not force the cover.

NOTE: Always wait a minute or two when replacing batteries so that the internal electronics discharge and can recognize the change.

4.4 Lamp and Filter Replacement

Use the following instructions when replacing the lamp. The lamp is located at the back of the projector (below the input panel) and can be accessed by removing the lamp access panel. Use only the Christie approved **Lamp and Filter Kit** for your specific projector model. See Table 4.2 below.

Table 4.2. Lamp/Filter Replacement Kits

Projector Model	Model Number	Lamp Type (Watts)	Lamp/Filter Kit Required
Mirage S+3K	38-DSP102-xx	500W	003-120118-01
Mirage HD3	104-012101-xx		
Christie HD3K	104-025101-xx		
Mirage WU3	104-060107-xx		
Christie HD2Kc	104-026101-xx		
Matrix S+2K	38-DSP102-xx		
Matrix HD2	104-023101-xx		
Matrix WU2	104-058104-xx		
DLV1400-DX	38-DSP102-xx		
DLV1920-DX	104-017101-xx		
Christie DS+6K	38-DSP104-xx		
Christie DS+5Kc	38-DSP104-xx		
Christie DW4Kc	38-DHD103-xx		
Christie DW5K	38-DHD103-xx		
Christie HD6K	104-006101-xx		
Christie HD5Kc	104-007101-xx		
Mirage HD6	104-013101-xx		
Mirage S+6K	38-DSP104-xx		
Mirage WU7	104-061108-xx		
Matrix 4000	38-DSP104-xx		
Matrix S+5K	38-DSP104-xx		
Matrix HD4	104-016101-xx		
Matrix WU5	104-059105-xx		
Christie DS+8K	38-DSP106-xx	1200W	003-120116-01
Christie DW6Kc	38-DHD106-xx		
Christie DW8K	38-DHD106-xx		
Christie HD8K	104-008101-xx		
Christie HD7Kc	104-018101-xx		
Matrix HD7	104-024101-xx		

A lamp should be replaced when it reaches its end of life or sooner if a noticeable degradation in brightness occurs (typical in aging lamps). You can set the number of hours you expect to log with the lamp before replacing it, by setting the **Lamp Limit** in the *Lamp* menu. The LED's next to the built-in keypad will flash "LP" when lamp time has expired. You can also enable a warning message to appear upon powering up the projector that will indicate the lamp has reached the limit you set, by entering a checkmark beside the **Lamp Message** option.

NOTE: *The lamp mode you choose to run the projector in may have an impact on the number of hours expected for the lamp.*

Tools required: #2 Phillips screwdriver

Warnings

- A qualified service technician must perform lamp replacement.
- Cool the lamp completely and handle by the housing only.
- Install the correct wattage lamp supplied by Christie (see above) and read the Lamp Replacement procedure in its entirety before proceeding.
- Do not touch the glass surface of the lamp. Fingerprints left on the surface can lead to an intense accumulation of heat called a "hotspot", which could potentially result in the lamp shattering. It is recommended you wear clean, lint-free gloves and a face shield when working with the lamp.

1. TURN THE LAMP OFF

Press  (power) to turn the lamp off. Allow the cooling fans to stop automatically (within approximately five minutes) before proceeding with Step 2. This wait period is also required to allow the lamp to sufficiently cool before handling.

2. UNPLUG THE PROJECTOR

When the cooling fans have stopped, turn the projector’s main switch off, and unplug.



Always power down and unplug the projector prior to servicing. Allow the lamps to cool before handling

3. REMOVE THE LAMP DOOR



Protective gear required. Wear a face shield.

Using a #2 Phillips screwdriver, remove the two (2) screws securing the lamp door, which is located at the rear of the projector below the input panel. See Figure 4.2.

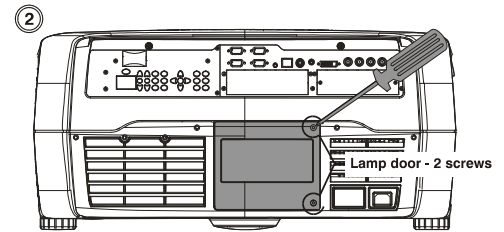

Figure 4.2. Open Lamp Door

4. RELEASE THE LAMP LOCK

Pull out and turn the lamp lock lever, which is located to the left of the lamp module, and turn it ¼ turn counter clockwise to the “unlock” position. See Figure 4.3.

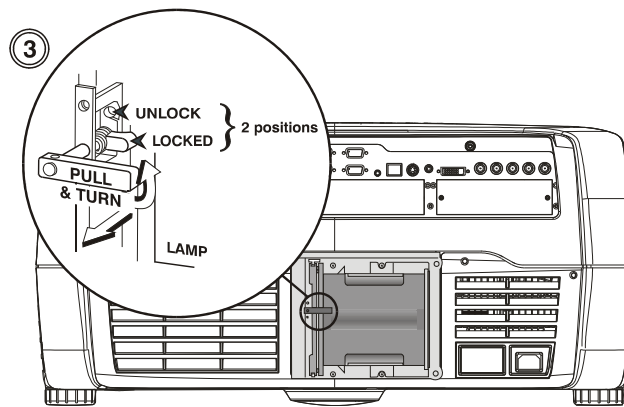

Figure 4.3. Release the Lamp Lock

5. REMOVE THE LAMP MODULE

Firmly grasp the lamp by its housing only and pull it straight out (lamp slides along guides) until it is free. See Figure 4.4. Discard the lamp using safe disposal/recycling practices.

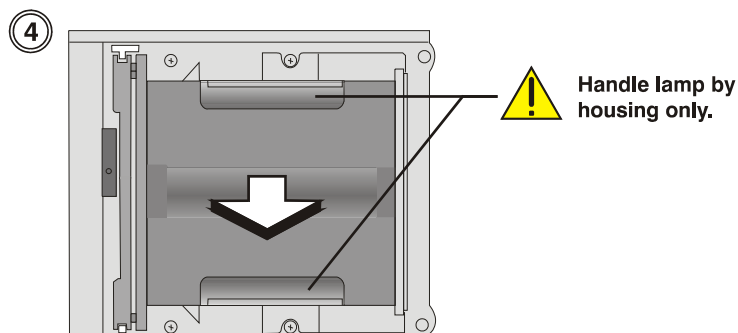

Figure 4.4. Remove Lamp Module

6. INSERT THE NEW LAMP MODULE

Align the new lamp with the top and bottom guides on the left side of the lamp compartment (see Figure 4.5). Slide the lamp all the way in – a slightly harder push may be required right at the end to ensure it is fully seated into the terminal block.

NOTE: *The lamp module must make **full contact** with the terminal block. The projector will not power up again if the lamp is not fully connected to the terminal block.*

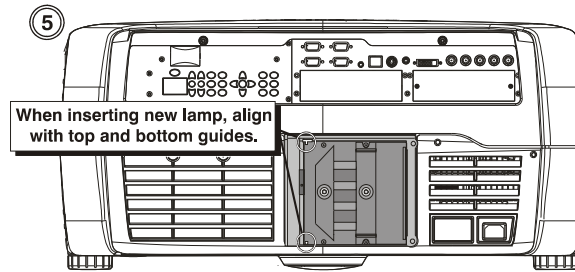

Figure 4.5. Insert New Lamp Module



WARNING

Improper installation could cause a serious meltdown inside the projector.

7. LOCK IN THE NEW LAMP MODULE

Pull out and turn the lamp lock lever (turned up in Step 4) $\frac{1}{4}$ turn clockwise to “lock” the lamp in place.

NOTE: *If you can't turn the lamp lock into position, it is likely the lamp is not fully inserted. In this case, partially remove the lamp and try pushing it back in again. Then, try switching the lock lever to the “lock” position.*

8. REPLACE THE LAMP DOOR

Replace the lamp door and secure it with the two (2) screws removed in Step 2.

IMPORTANT: The lamp module is calibrated for maximum performance and brightness in this projector. Do not attempt to re-align or adjust the lamp module.

9. RECORD THE SERIAL NUMBER OF THE NEW LAMP

- Plug in the projector and power it up.
- In the Lamp menu, select “Change Lamp”.
- In the Lamp S/N text box, enter the serial number.
- Press to record the number and to reset the lamp timer. The timer will now begin to log time for the new lamp.

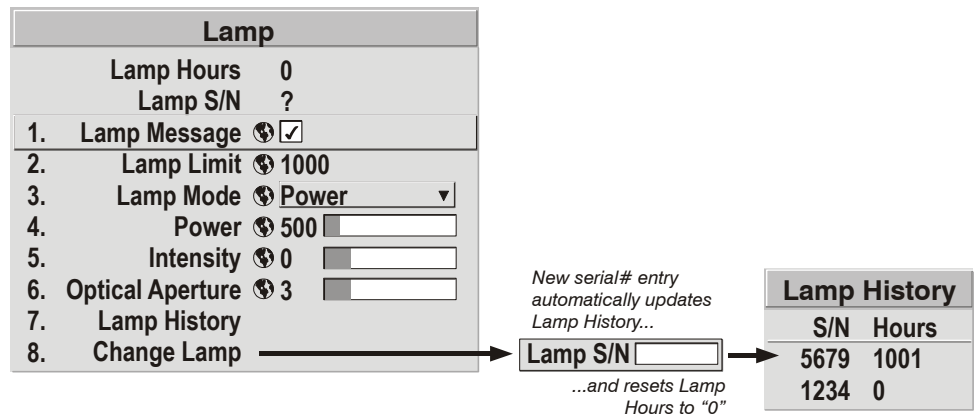

Figure 4.6. Lamp Menu

IMPORTANT: If you neglect to enter a serial number, the lamp timer will not reset to “0” and will therefore be inaccurate. The lamp life limit may then expire prematurely.

Filter Replacement Procedure ▶

⚠ WARNING ⚠
Use Christie approved filters ONLY.

The two filters located at the front and left side of the projector should be replaced whenever the lamp is replaced. If you are working in an extremely dusty environment you may want to replace the filters sooner. Use the filters provided in the Christie approved Lamp and Filter Kit for your specific projector model.

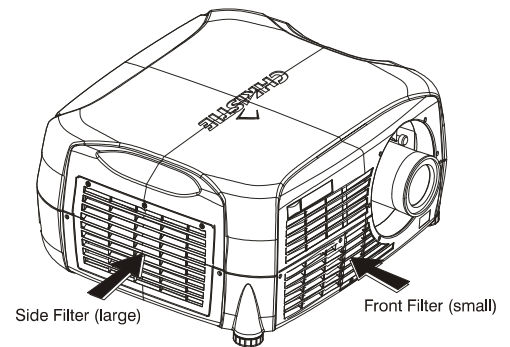

Figure 4.7. Filter Location

1. TURN OFF THE PROJECTOR, COOL and UNPLUG

Before removing or installing a filter, turn off the projector and allow it to cool for five minutes before unplugging.

2. REMOVE FILTER ACCESS PANELS

Loosen the captive screw(s) on the filter access panels using a #2 Phillips screwdriver. (Front access panel located to the left of the lens – one screw. Left side access panel – three screws. See Figure 4.6.)

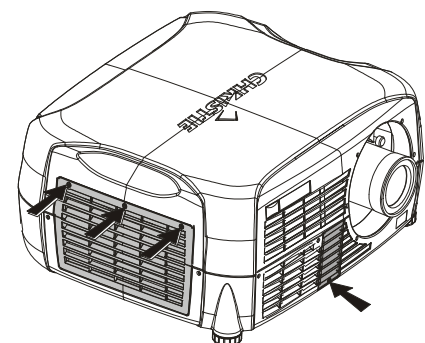

Figure 4.8. Remove Filter Access Panels

3. REPLACE FILTERS

Pull the old filters out of the projector and discard. Do not reuse filters. Insert the new filters with the wired side in. See Figure 4.7.

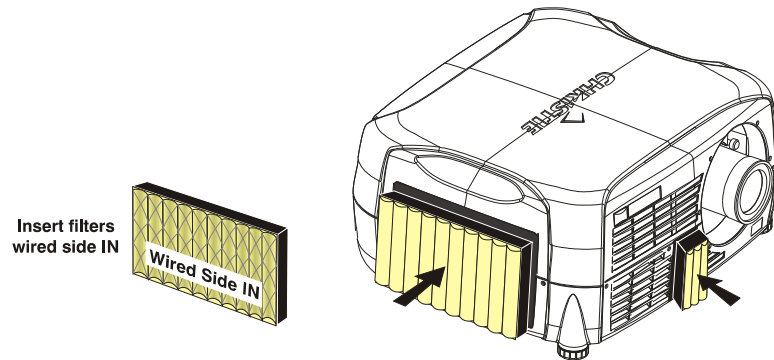

Figure 4.9. Insert New Filters

4. REPLACE ACCESS PANELS

Replace the two (2) filter access panels and tighten the screws loosened in step 1.

4.5 Replacing the Projection Lens

A variety of lenses can accommodate different throw distances and specific types of installations. Refer to *Section 6 - Specifications* for details. To change a lens, follow the steps below.

STEP 1 ▶ **Turn off the projector, cool and unplug**

NOTE: *If necessary, a lens can be swapped out while the projector is running, but this can result in dust being drawn into the projector. Avoid if possible.*

Before removing or installing any lens, turn off the projector and allow the fans to cool the lamp before unplugging the projector. Ensure that the lens cap is on.

⚡ WARNING ⚡
Unplug the projector.

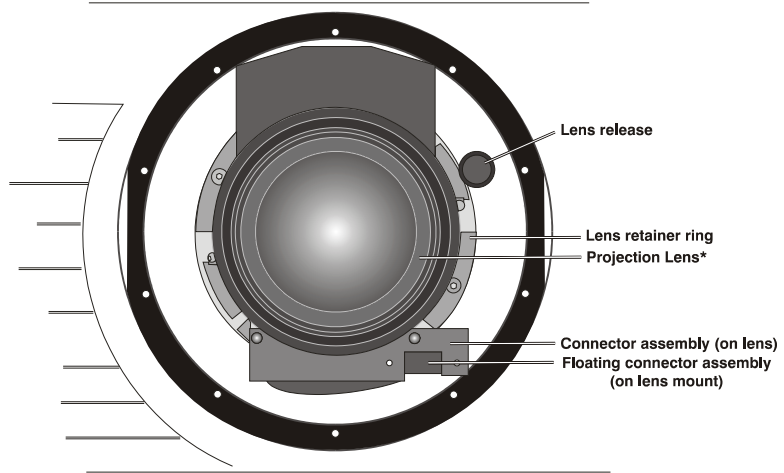

Figure 4.10. Lens Assembly

STEP 2 ▶ Install the lens cap and press the lens release button
See Figure 4.11.

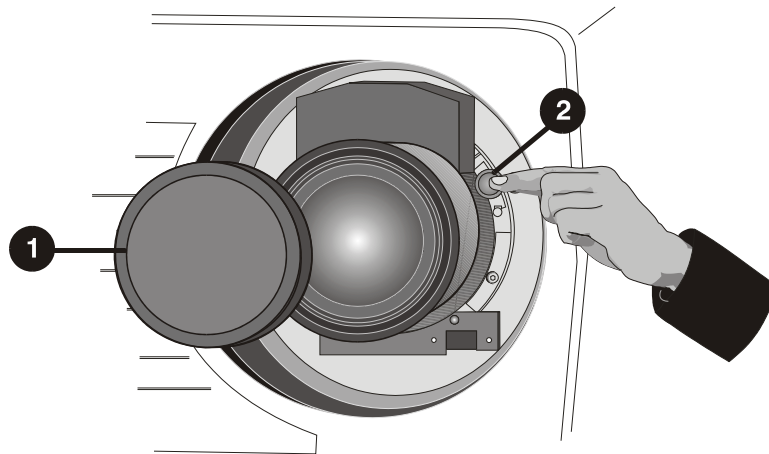

Figure 4.11. Depressing Lens Release

STEP 3 ▶ Rotate the lens

Rotate the lens counter-clockwise until the tabs are free from the lens retainer ring, see A in Figure 4.12.

NOTE: The connector slide assembly allows the connector to move as the lens is rotated.

STEP 4 ▶ Pull lens out

Lens connectors will disconnect when you pull the lens straight out from the projector, see B in Figure 4.12.

STEP 5 ▶ Insert new lens.

NOTE: Remove small rear cap! Keep front cap on.

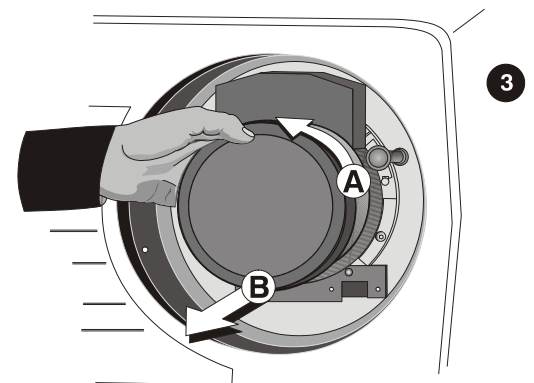

NOTE: Connector assembly will move as you turn the lens.

Figure 4.12. Rotating the Lens

- **Electrical connector:** Line up male connector on the lens with the female connector on the connector slide assembly.
- **Insert lens:** Align the tabs on the lens plate lock with the slots in the lens retainer ring. Push the lens in until the tabs touch the back of the retainer ring.
- **Rotate the lens:** To ensure the lens is secured in the lens mount, turn it clockwise until you feel the tabs on the lens butting against the end stops on the lens mount retaining ring. To ensure the locking pin is properly engaged, turn the lens counter-clockwise. If the lens does not turn counter-clockwise, the locking pin is properly engaged. If the lens turns counter-clockwise, the locking pin is not properly engaged; in this case, turn it clockwise and pull the lens plunger assembly out until the plunger assembly stops. Recheck by turning the lens counter-clockwise. The lens should not rotate.
- **Secure stability screws (optional):** For added stability, secure the adjustment screws provided on the lens-retaining ring (see Figure 4.13). If you have installed a large zoom lens, one or more of the screws may be inaccessible—simply tighten those that are accessible (Figure 4.14).

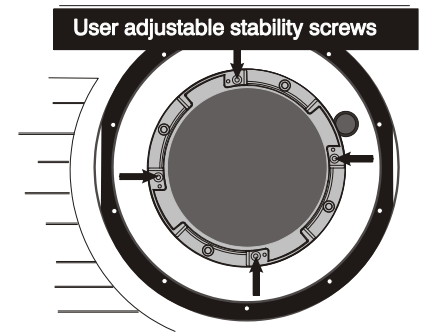

Figure 4.13. Adjustable Screws on Retaining Ring

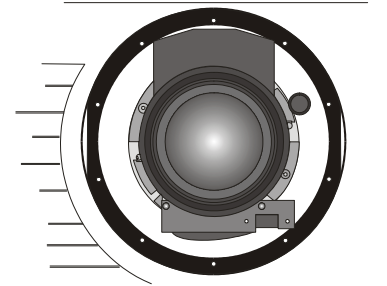

Figure 4.14. View with Zoom Lens Installed

NOTE: Recommended for heaviest lenses such as 0.73:1 and 1.2:1.

STEP 6 ▶ Power Up

Remove the lens cap and power up the projector.

STEP 7 ▶ Reposition the Projector for New Lens

Reposition the projector closer or further from the screen as necessary for the screen and the new lens type – refer to lens descriptions in **Section 2**, **Section 6** and **the Dealer Section of the Christie Website, PN 020-100298-xx**. In a permanent installation, always use the appropriate throw distance formula to calculate the best position for the projector.

Troubleshooting





If the projector does not appear to be operating properly, note the symptoms present and use the following guide to assist you. If you cannot resolve the problems yourself, contact your dealer for assistance.

NOTE: A Christie accredited service technician is required when opening the projector to diagnose any “probable cause”.

5.1 Displays

Symptom ▶ **The projector is on but there’s no display...**

CAUSE / REMEDY:

1. Was a lens cover accidentally left on? Remove lens cover.
2. Ensure the shutter is OPEN.
3. Is the lamp ignited? Check for interlock problems such as an open lamp door OR check for light spillage out the back.
4. Is the correct input selected? Check cable connections.
5. Check if menus appear on screen.
6. Can you access test patterns? Ensure a full black test pattern has not been selected for display—press   to access test patterns, then cycle patterns with   keys. Check your source connections again.

Symptom ▶ **Severe motion artifacts...**

CAUSE / REMEDY:

1. Most likely there is a synchronization problem with reversed 3/2 pull-down in 60Hz-to-24Hz film-to-digital conversion in your source. Correct at the source.

Symptom ▶ **Image appears “squeezed” or vertically stretched into center of screen**

CAUSE / REMEDY:

1. Check your Resizing selection.

Symptom ▶ **The display is jittery or unstable...**

CAUSE / REMEDY:

1. If the display is jittery or blinking erratically, ensure that the source is properly connected and of adequate quality for detection. With a poor quality or improperly connected source, the projector will repeatedly attempt to display an image, however briefly.
2. The horizontal or vertical scan frequency of the input signal may be out of range for the projector. Refer to **Section 6, Specifications** for scan frequency ranges.
3. The sync signal may be inadequate. Correct the source problem.

Symptom ▶ The display is faint...**CAUSE / REMEDY:**

1. Brightness and/or contrast and/or gamma may be set incorrectly.
2. The source may be double terminated. Ensure the source is terminated only once.
3. The source (if non-video) may need a different sync tip clamp location.

Symptom ▶ The upper portion of the display is waving, tearing or jittering...**CAUSE / REMEDY:**

1. This can sometimes occur with video or VCR sources. Check your source.

Symptom ▶ Portions of the display are cut off or wrap to the opposite edge...**CAUSE / REMEDY:**

1. Resizing and/or blanking may need adjustment.
2. The horizontal or vertical scan frequency of the input signal may be out of range for the projector. Refer to *Section 6, Specifications* for scan frequency ranges.

Symptom ▶ The display appears compressed ...**CAUSE / REMEDY:**

1. The frequency of the pixel-sampling clock is incorrect for the current source.
2. Resizing, vertical stretch and positioning options may be improperly adjusted for the incoming source signal.

Symptom ▶ Data is cropped from edges**CAUSE / REMEDY:**

1. Check settings for Blanking.
2. If incoming data is still missing from the image, reduce the image size to within the display area available in the projector.

Symptom ▶ Display quality appears to drift from good to bad, bad to good...**CAUSE / REMEDY:**

1. The source input signal may be of low quality.
2. The H or V frequency of the input may have changed at the source end.

Symptom ▶ The display has suddenly frozen...**CAUSE / REMEDY:**

1. It's possible that excessive voltage noise on the AC or ground input has interrupted the projector's ability to lock on to a signal. Power down the projector and disconnect from AC. Then plug in again and power up as usual.

Symptom ▶ Colors in the display are inaccurate...**CAUSE / REMEDY:**

1. Try Auto Setup.
2. The color, tint, color space, color temperature and/or other settings may require adjustment.
3. Ensure signal connections are correct.
4. Ensure the proper channel for this source is being used.

Symptom ▶ Values in Color Saturation slide bars vary over time...**CAUSE / REMEDY:**

1. Once defined, *Color Saturation* slide bar values fluctuate over time and will likely be different upon subsequent visits to this menu. This is normal and should be ignored, as these changes do not redefine the x/y coordinates or color gamut.

Symptom ▶ The display is not rectangular...**CAUSE / REMEDY:**

1. Check leveling of the projector. Ensure the lens surface and screen is as parallel to each other as possible.
2. Is the vertical offset correct? Adjust as necessary using the vertical offset knob.

Symptom ▶ The display is “noisy”...

CAUSE / REMEDY:

1. Display adjustment at your input source may be required. Adjust pixel tracking, phase and filter. Noise is particularly common on YPbPr signals from a DVD player. (If using a PC source, adjust using a high-frequency test pattern with one pixel on/off throughout.)
2. The video input may not be terminated. Ensure the video input is terminated (75Ω). If it is the last connection in a loop-through chain, the video input should be terminated at the *last* source input only.
3. The input signal and/or signal cables carrying the input signal may be of poor quality.
4. If the distance between the input source device and the projector is greater than 25 feet, signal amplification/conditioning may be required.
5. If the source is a VCR or off-air broadcast, detail may be set too high.

5.2 Lamp

Lamp Does Not Ignite ▶

1. If the lamp won't ignite, there may be an interlock failure such as an open lamp door, or failed lamp fan. An error code will display on the status LED display located on the built in keypad.
2. If a temperature is too high (e.g. “DMD over critical temp limit”), the lamp will not ignite until the temperature is low enough. Cool the projector and try again.
3. For suspected communication failures, power-down the projector and try again.
4. If the lamp does not ignite after a second and third try, replace the lamp.

Lamp Suddenly Turns Off ▶

1. Try increasing the lamp power.
2. The DMDs may be overheated.
3. Replace the lamp.

Flicker, Shadows Or Dimness ▶

1. Increase lamp power, if possible.
2. Replace the lamp.

LiteLOC™ Does Not Seem To Work ▶

1. Ensure the “Intensity” is selected in the *Lamp* menu. Other lamp modes disable LiteLOC™.
2. If the lamp power has increased to its maximum in order to maintain a LiteLOC™ setting, LiteLOC™ is automatically terminated. If the values shown in the *Lamp* menu indicate that the lamp power has reached this “over-drive” state, either reduce your LiteLOC™ setting or install a new lamp.

5.3 Ethernet

1. Ensure the Ethernet settings are valid for your site—all network devices should have the *same* subnet mask and *unique* IP addresses.
2. Ensure any address changes have been saved, and re-boot to implement.
If you still have trouble establishing communications with a projector added to an existing Ethernet network, the projector's IP address is likely in conflict with another address already in use. Contact your network administrator.

5.4 3D Sync Input

Symptom ▶ **System Error Code 1E...**

- CAUSE / REMEDY:**
1. Cable not connected to specified Sync Input.
 2. Connect cable.

Symptom ▶ **System Error Code 1F...**

- CAUSE / REMEDY:**
1. Sync is present, but out of range.
 2. Previous hook up to projector was sending Sync to Emitter. Change 3D Sync Output to Next.

Specifications

6.1 Specifications

NOTES: 1) Due to continuing research, specifications are subject to change without notice.
2) Specifications apply to all models unless otherwise noted.

Display ► Resolution

SXGA+ (1400 x 1050) for *DS+6K-5Kc-8K/MirageS+3K-6K-8K/Matrix S+2K- 5K and DLV1400-DX*

HD (1920 x 1080, widescreen) for *HD6K-5Kc-8K-7Kc/Matrix HD2-HD4-HD7/DLV1920-DX, HD3K, HD2Kc/Mirage HD3, HD6, HD8, Matrix 4000, WUXGA (1920 x 1200, widescreen) for Matrix WU2-WU5/Mirage WU3-WU7*

HD2 (1280 x 720, widescreen) for *DW5K-4Kc/DW8K-6Kc*

Achievable Brightness (ANSI lumens 9 point, fully open aperture)

500W

	<u>Min.</u>	<u>Nom.</u>	<u>Max.</u>
<i>Mirage S+3K</i>	2000	3000	3500
<i>DLV1400-DX</i>	2000	3000	3500
<i>Matrix S+2K</i>	2000	3000	3500
<i>Matrix WU2</i>	2000	3000	3500
<i>Mirage HD3</i>	2000	2700	3500
<i>Mirage WU3</i>	2000	2700	3500
<i>Matrix HD2</i>	1900	2500	3200
<i>DLV1920-DX</i>	2000	2700	3500
<i>Christie HD3K</i>	2500	2900	3500
<i>Christie HD2Kc</i>	1900	2300	2800

1000W

<i>Christie DS+6K</i>	5500	6500	7500
<i>Christie DS+5Kc</i>	5500	6500	7500
<i>Mirage S+6K</i>	5500	6500	7500
<i>Matrix S+5K</i>	4320	5200	5800
<i>Matrix 4000</i>	4320	5200	5800
<i>Christie DW5K</i>	4000	4500	6800
<i>Christie DW4Kc</i>	3350	4250	5700
<i>Mirage HD6</i>	5300	5900	7500
<i>Matrix HD4</i>	4320	5200	5800
<i>Christie HD5Kc</i>	4320	5200	5800
<i>Christie HD6K</i>	5300	5900	7500
<i>Matrix WU5</i>	4320	5200	5800
<i>Mirage WU7</i>	5300	5900	7500

Achievable Brightness (ANSI lumens 9 point, fully open aperture)

1200W

Christie DS+8K	7000	8000	8800
Mirage S+8K	7000	8000	8800
Christie DW8K	6600	7500	8500
Christie DW6Kc	5500	6300	7150
Christie HD8K	7000	7800	8800
Christie HD7Kc	5580	6200	7000
Mirage HD8	7000	7800	8800
Matrix HD7	5580	6200	7000

Contrast Ratio (ANSI, full field, min.)

450:1 ANSI

1500:1 full field for SXGA+, 1500-2000:1 full field for HD, 2000:1 full field for Matrix S+5K only

Color Primaries (nominal)

Without Yellow Notch Filter

With Yellow Notch Filter

	X	Y		X	Y
R	0.660	0.330	R	0.680	0.320
G	0.310	0.640	G	0.265	0.690
B	0.145	0.065	B	0.145	0.060

Colors and Gray Scale

Resolution	10 bits
Displayable colors	1.1billion

Color Temperature

Default	5800K +950K/-650K
HD Default	6300K +/- 500K
Range of Adjustment (see Note 1)	3200K – 9300K

NOTE 1: Via electronic controls, with Comprehensive Color Adjustment™ turned off.

Lenses ▶

Lenses	Offsets (Movement)		Max. Amount of Display Above or Below Lens Center	Max. Amount of Display Left or Right of Lens Center	
	↑ or ↓	← or →			
SX+ Offsets					
0.73:1 Fixed	40%	25%	735 pixels ↑ or ↓	70%	875 pixels ← or →
1.25-1.6:1 Zoom	73%	45%	908 pixels ↑ or ↓	86%	1015 pixels ← or →
All other SX+lenses	100%	50%	1050 pixels ↑ or ↓	100%	1050 pixels ← or →
HD Offsets					
.67:1 Fixed HD	47%	19%	794 pixels ↑ or ↓	73%	1142 pixels ← or →
1.16-1.49:1 Zoom HD	102%	40%	1091 pixels ↑ or ↓	100%	1344 pixels ← or →
All other HD lenses	119%	42%	1183 pixels ↑ or ↓	100%	1363 pixels ← or →
WU Offsets					
.67:1 Fixed HD	22%	6%	732 pixels ↑ or ↓	61%	1018 pixels ← or →
1.16-1.49:1 Zoom HD	82%	38%	1092 pixels ↑ or ↓	91%	1325 pixels ← or →
All other HD lenses	112%	54%	1272 pixels ↑ or ↓	100%	1478 pixels ← or →

NOTES: 1) 0% offset is equal to half the image above and below lens center OR half the image to the left or right of lens center. 2) Offsets are subject to a ± 7% centering tolerance.

Inputs ▶ Standard Analog RGB or YPbPr (Interlaced or Progressive Scan Format)

Horizontal Frequency Range		31 – 120 kHz
Vertical Frequency Range (See Note 2)		23.97 – 150 Hz
Scan format		Interlaced or progressive
Pixel Clock Rate (max.)		220 MHz max
Signal Format		Analog RGB, YPbPr, Composite (on “G/Y/CVBS” input and S-video (luma on “R/Pr/Y” input and chroma on “B/Pb/C” input)
Input Levels	R, G, B, - with sync:	1.0V _{p-p} ±2 dB
	R, G, B, - without sync:	0.7V _{p-p} ±2 dB
	Pb, Pr	0.7V _{p-p} ±2 dB
Nominal Impedance		75 ohms

NOTE 2: Value specifies frame rate of non-interlaced sources and field rate for interlaced sources. Frame/field rates higher than the maximum refresh rate of the panels will be displayed at a lower rate (i.e., frames will be dropped).

Sync (Interlaced or Progressive Scan Format)

Horizontal Frequency Range		31 – 120 kHz
Vertical Frequency Range (See Note 3)		23.97 – 150 Hz
Sync Type		Separate H and V, direct or swapped Composite (bi-level, tri-level, XOR, OR) Sync-On-Green/luma (bi-level, tri-level) Serration and /or Equalization pulses MacroVision™ for standard & progressive video
Polarity (See Note 3)		Positive or Negative
Input Levels (See Note 3)		0.5V _{pp} – 4.0V _{pp}
DC Offset (See Note 3)		±3V
Nominal Impedance (See Note 3)		75 ohms
Horizontal Sync Duty Cycle		3% min, 20% max

NOTE 3: Does not apply to sync-on-green/luma.

Composite Video and S-Video

Signal Formats		Composite-video (CVBS), S-video (Y/C)
Video Standards		NTSC, NTSC 4.43, PAL, PAL M, PAL N, PAL60, SECAM
Input Levels	Composite-video:	1.0 V _{p-p} ±3 db (including sync tip)
	S-video luma (Y):	1.0 V _{p-p} ±3 dB (including sync tip)
	S-video chroma I:	630 mV nominal (burst)
DC Offset		±2 V
Nominal Impedance		75 ohms
Return Loss (VSWR)		20 dB min (1.2:1 max.) @ 6 MHz

DVI-I Input

Interface Standard	DDWG DVI 1.0
Signal Types	- RGB (Analog or Digital) - YPbPr (Analog) - YCbCr (Digital)
Color Space	RGB or YPbPr
Horizontal Frequency Range	31 – 120 kHz
Vertical Frequency Range	23.97 – 150 Hz
Pixel Clock Rate	25 – 165 MHz
Scan Format	interlaced or progressive
Active Pixels per scan line	640 min., 2048 max.
Active Lines per field / non-interlaced frame	200 min., 1536 max
Connector type	DVI-I

NOTE: *HDCP compatible. (Not supported in v1.1 s/w)*

RS-232 Serial Input

Connector Type	One female 9-pin Dsub (RS232 IN) One male 9-pin Dsub (RS232 OUT)
----------------	---

RS-422 Serial Input

Connector Type	One female 9-pin Dsub
----------------	-----------------------

GPIO

Connector Type	One male 9-pin Dsub
Number of I/O lines	7 (each individually assignable as input or output)
Power Output	+12VDC @ 200mA max.
Output sink current (logic low)	100mA @ 1V

Ethernet

Connector Type	One female RJ45
Maximum throughput	115.2kbps

Remote Control

Number of sensors	Two
Type	IR with wired ability
Range (using std. keypad)	100 feet
Battery type (2 required)	AA, 1.5 V Alkaline

Laser Diode (laser pointer)	Wavelength	670nm
	Max. Output	1mW

Wired Control

Connector type	3.5mm RCA jack
Input levels	High: 2.2 V – 5.6 V (or open) Low: -0.6 V – 0.9 V @ 1 mA

Power Requirements

⚠ Voltage range

500W models	100 – 240VAC
1000W models	100 – 240VAC
1200W models	200 – 240VAC
Line frequency	50 Hz – 60 Hz nominal
Max. Inrush current	60A max.
Current rating	
500W models	10A @ 100V
1000W models	10.4A @ 100V
1200W models	10A @ 200V
Power consumption	
500W models	1000 W max.
1000W models	1600 W max.
1200W models	2000 W max.
Current rating or AC input connector	15A
Type of Connector (back of projector)	IEC 320 C14

⚠ Line Cords

500W models	heavy duty 10', 100VAC 15A
1000W models	heavy duty 10', 100VAC 15A
1200W models	heavy duty 12', 220VAC 15A

⚠ Plugs

500W models	NEMA 5-15P
1000W models	NEMA 5-15P
1200W models	NEMA 6-15P

Lamps

Type	CERMAX® Xenon
Power	
<i>Mirage S+3K, Matrix S+2K, Christie HD3K, DLV1400-DX, DLV1920-DX, Christie HD2Kc, Mirage HD3, Mirage WU3, Matrix HD2, Matrix WU2</i>	500W
<i>Mirage S+6K, Mirage HD6, Mirage WU7, Christie DS+6K/5Kc, Christie HD6K/5Kc, Christie DW5K/DW6Kc, Matrix S+5K, Matrix HD4, Matrix WU5, Matrix 4000</i>	1000W
<i>Mirage S+8K, Christie DS+8K, Mirage HD8, Christie HD8K/7Kc, Matrix HD7, Christie DW8K/DW6Kc</i>	1200W
Adjustment Ranges	
500W models	350 – 500W
1000W models	700 – 1000W
1200W models	800 – 1200W
Lamp Life (typ.)	
500W models	2500 hrs @ 500W
1000W models	1500 hrs
1200W models	1500 hrs

Call for warranty information

Operating position

Full rotation allowed about the lamp axis, ± 15 degrees minimum tilt of lamp axis from horizontal
10 minutes max.

Warm up to full brightness

26.0" x 22.3" x 12.3"
660mm x 566mm x 313mm

Size and Weight ▶ Dimensions (*without lens*)
(Including feet at min. height position)

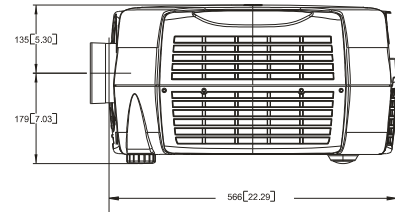
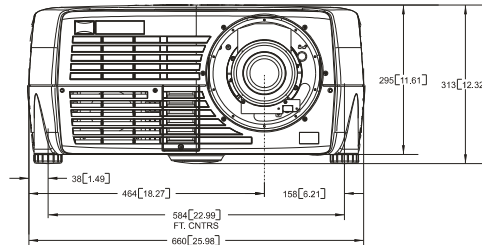

DIMENSIONS: Millimeters [Inches]

Weight (*without lens*)

500W models

75 lb. Max

1000W models

75 lb. Max

1200W models

80 lb. Max

Safety ▶ UL 60950-1 1st edition and CAN/CSA C22.2 No. 60950-1-03 1st edition
IEC 60950-1:2001
IEC 60825 for laser in IR remote controller

EMC Emissions ▶ FCC CFR47, Part 15, Subpart B, Class A — Unintentional Radiation
CISPR 22/ EN55022— Radio disturbance characteristics for ITE

EMC Immunity ▶ CISPR 24 / EN55024 (all parts of immunity characteristics for ITE)

Operating Environment ▶ Temperature 5°C to 35°C (41°F to 95°F)
Humidity 20% to 80%, non-condensing
Altitude 0 – 3000 meters

Non-Operating Environment ▶ Temperature -40°C to 70°C (-40°F to 149°F)
Humidity (non-condensing) 0% to 95%

Standard Components ▶ IR keypad (*includes two, 1.5V AA batteries and a mini-stereo cable for conversion to wired*)
Line Cord
3D Stereo Sync Cable (*Mirage products only*)

Optional Accessories ▶

- Wired remote keypad
- Two-way remote controller
- Remote IR sensor
- Ceiling Mount Extension
- Service Manual
- Ethernet, RS-232 and RS-422 communication cables
- KoRE Librarian for downloading new software
- Ceiling Mount
- Stacking Frame

Lenses (HD)

- | | | | |
|--------------------|-----------------|--------------------|-----------------|
| • 0.67:1 fixed | (104-110101-01) | • 1.38-1.84:1 zoom | (104-112101-01) |
| • 1.1:1 fixed FP | (104-111101-01) | • 1.84-2.58:1 zoom | (104-113101-01) |
| • 1.1:1 fixed RP | (104-116101-01) | • 2.58-4.15:1 zoom | (104-114101-01) |
| • 1.16-1.49:1 zoom | (104-137101-01) | • 4.15-6.74:1 zoom | (104-115101-01) |
| | | • 6.9-10.4:1 zoom | (104-130101-01) |

Optional Input Modules

RGB500 Input Module

RGB400 Active Loop-Through Input Module

RGB400 Buffered Amplifier Input Module

PC250 Analog Input Module

Serial Digital Input Module

DVI Input Module

Dual SD/HD-SDI Module *(Standard with the Christie HD Series, optional for Mirage and Matrix models).*

Keypad Reference

NOTE: The IR remote is a standard component provided with the projector. Use the extension cable also provided to convert the IR remote to a wired remote, if desired. Refer to **Section 3** for a specific description of each key and how to use them correctly.

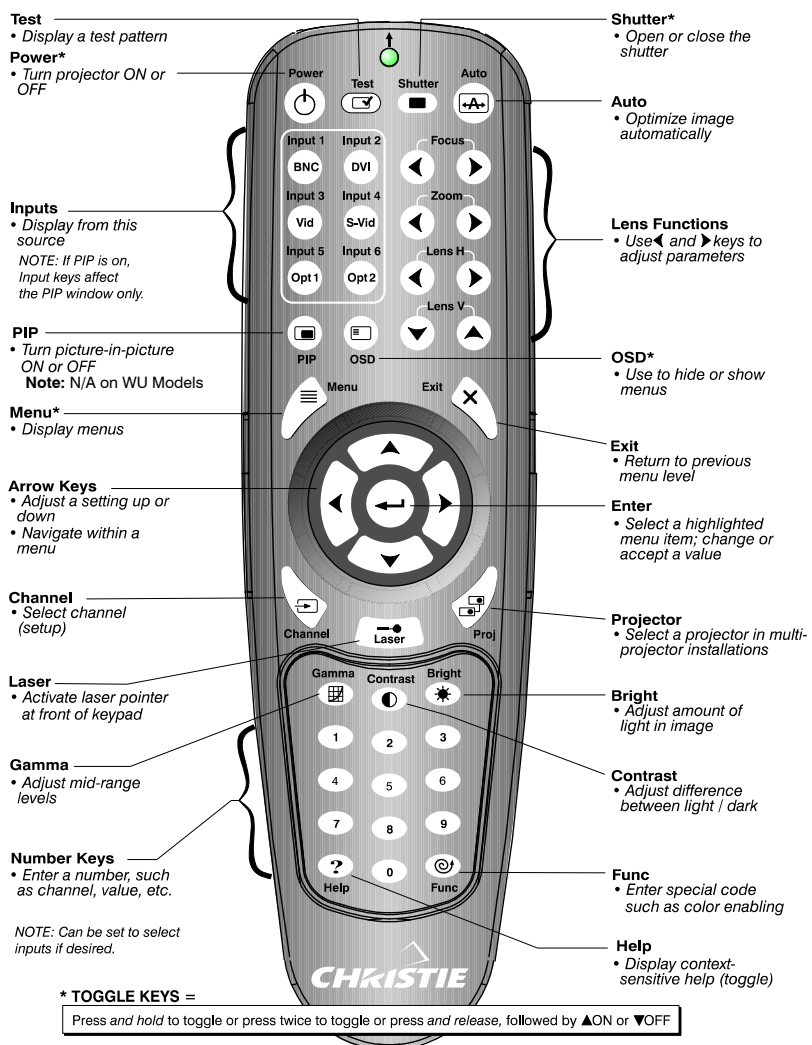

* Toggle keys, which require you to either, press and hold, or press twice or press and use the up/down arrow key.

Serial Communication Cables

A serial link of RS232 or RS422 enables ASCII communication with the projector so that it can be controlled remotely from a PC or other controller. From a PC, connect a standard nine-wire RS232 serial cable to the **RS232 IN** port. Or, for long-distance (>100 ft.) links with an RS422-compatible PC or controller, connect RS422 cable to the **RS422** port.

□ **From projector to computer (RS232)**

For computers having a 9-pin "AT" type serial port

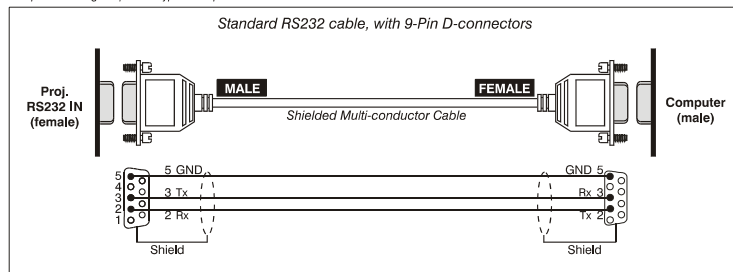

□ **From projector to projector**

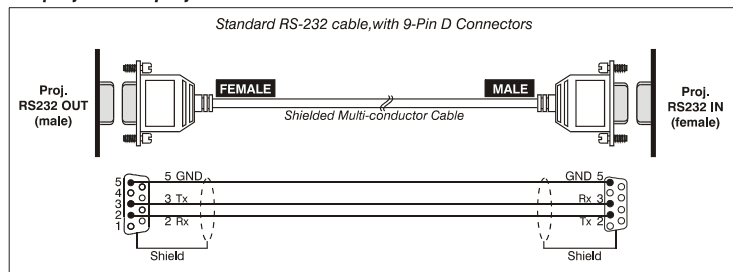

□ **From projector to RS422 compatible computer**

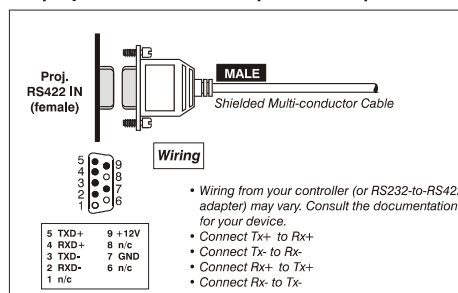

System Integration

The GPIO (General Purpose Input Output) connector located on the input panel provides a flexible method of interfacing a wide range of external I/O devices to the projector. There are seven GIO pins available on the nine-pin D-Sub GPIO connector, which are configurable via RS232 commands. The other two pins are reserved for ground and power – see table below for pin identification.

GPIO Pins		GPIO	
Pin #	Signal		
1	+ 12V (200mA)		
2	GPIO 1		
3	GPIO 2		
4	GPIO 3		
5	Ground		
6	GPIO 4		
7	GPIO 5		
8	GPIO 6		
9	GPIO 7		

The serial cable required for connecting the external device to the projector's GPIO connector, whether it's a standard serial cable or a custom one, must be compatible with the external device.

Configuring the GPIO

The GPIO connector can be configured to automate any number of events using the serial command code **GIO**. Each pin is defined as either an **input** or **output** depending on the desired outcome. In general, configure the pin as an input if you want the projector to respond to something the external device does and as an output if you want the external device to respond to an action taken by the projector. For example, configure the pin as an output if you want the lighting in a room to automatically dim when the projector is turned on.

By using the GIO command, you can also set the state of each pin as **high** or **low**. By default, the state of each pin is **high**. The voltage applied to pins in the **high** state is + 3.3V.

Example 1. Turn room lighting on when the projector is turned off. (*Assumes a control/automation unit is configured to turn the lights on when pin 2 of its input goes high.*)

(GIO C2 O)

Set pin #2 configuration to output

(GIO 2 H)

Set pin #2 to high (state)

Query Command

<i>(GIO?)</i>	<i>Request the state and configuration of all pins</i>
<i>(GIO! "HLLLHLH" "OOIOOOI")</i>	<i>Reply of pin state and configuration</i>
<i>(GIO? C2)</i>	<i>Request configuration for pin #2</i>
<i>(GIO! C2 O)</i>	<i>Reply with pin #2 configuration as output</i>
<i>(GIO? 2)</i>	<i>Request the state of pin #2</i>
<i>(GIO! H)</i>	<i>Reply with pin #2 state as high</i>

Real Time Event

Use the serial command **RTE** to specify an action that is initiated at a particular time or based on an external stimulus.

For General Purpose IO "G"

Parameter	Name	Value
P1	RTE type	G (Real Time I/O Event)
P2	I/O bit	1-7
P3	Pin state (1 Character) (String)	H = High L = Low "LHXXXHL" Combine multiple inputs and trigger occurs when all conditions are met
P4	Commands	Any valid serial protocol command for the device

Example 2. Projector powers up when a switch on the external device is turned on.

<i>(GIO C2 I)</i>	<i>Set pin #2 configuration as input</i>
<i>(RTE G 2 H "(PWR 1)")</i>	<i>Power on when pin #2 set to high</i>
<i>(RTE G 2 L "(PWR 0)")</i>	<i>Power off when pin #2 set to low</i>

Optional Input Modules

There are many optional input modules and accessories currently available for this projector. Contact your dealer for a complete and up-to-date listing.

- RGB500 Input Module 38-804606-xx** ▶ The *RGB500 Input Module* may be installed in this projector, a *Marquee Signal Switcher*, or a *Marquee Case/Power Supply*. The module receives analog RGB input signals from computers or other RGB source devices.

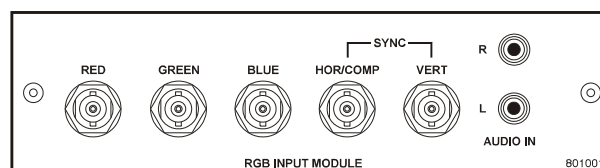

RGB500 Features

- Accepts 3, 4, or 5 wire RGB video (sync-on-green, composite sync, or separate horizontal and vertical sync), up to 500 MHz bandwidth
- Accepts YPbPr, composite (on green) and Y/C (on red/blue)
- BNC connectors for RGB signal inputs

NOTE: *The audio connectors are not functional.*

- RGB400BA Input Module 38-804610-xx** ▶ The *RGB400 Buffered Amplifier Input Module* may be installed in this projector, in a *Marquee Signal Switcher* or in a *Marquee Case/Power Supply*. Connect three-, four-, or five-wire RGB video signals of up to 400 MHz bandwidth, signals typically produced by high-resolution computer or workstations. The buffering capability of the module enables the incoming signal to be sent to a remote destination. Inputs are 75Ω terminated.

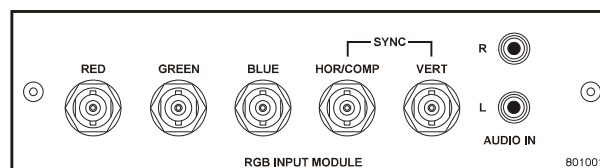

RGB400BA Features

- Accepts 3, 4, or 5 wire RGB video (sync-on-green, composite sync, or separate horizontal and vertical sync)
- Accepts YPbPr, composite (on green) and Y/C (on red/blue)
- BNC connectors for RGB signal inputs
- Buffered signals to a remote destination

NOTE: *The audio connectors are not functional.*

RGB400 Active Loop-Thru Input Module
38-804607-xx

► The *RGB400 ALT Input Module* may be installed in this projector, a *Marquee Signal Switcher*, or a *Marquee Case/Power Supply*. The module receives analog RGB input signals from computers or other RGB source devices. Video inputs are 75Ω terminated. Video outputs provide buffered loop-through to another display device.

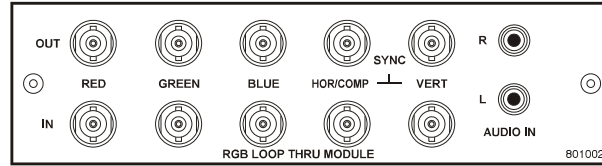

RGB400ALT Features

- Accepts 3, 4, or 5 wire RGB video (sync-on-green, composite sync, or separate horizontal and vertical sync)
- Accepts YPbPr, composite (on green) and Y/C (on red/blue)
- BNC connectors for RGB signal inputs
- Buffered loop-through video outputs

NOTE: *The audio connectors are not functional.*

PC250 Analog Input Module
38-804609-xx

► The *PC250 Analog Input Module* may be installed in this projector, a *Marquee Signal Switcher* or a *Marquee Case/Power Supply*. The module receives analog RGB input signals from IBM PC compatibles or Macintosh computers. Video inputs are 75Ω terminated. Video outputs are provided for buffered loop-through to another display device.

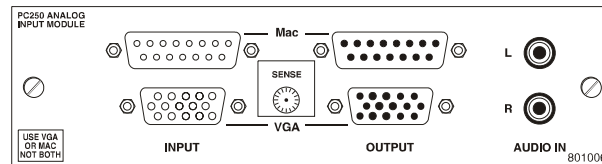

PC250 Analog Features

- Accepts VGA or MAC RGB video
- 15 pin D connectors for video
- Active loop-through video outputs

NOTES: **1)** *This interface does not accept VGA and MAC signals simultaneously.* **2)** *The audio connectors are not functional.* **3)** *Trademarks are the rights of their respective owners.*

DVI Input Module
38-804635-xx

► This module can display digital video input signals conforming to the DVI (Digital Visual Interface) single-channel standard.

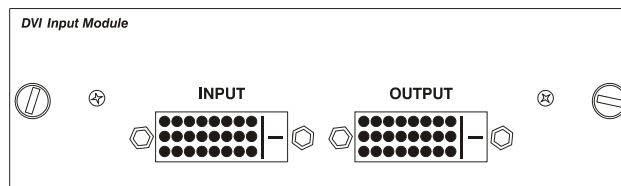

Features

- Supports Digital Visual Interface (DVI) single-channel
- Supports VESA® Extended Display Identification Data (EDID™)
- Provides an active-loop-through using a DVI connector (conforming to the DVI Specification)

Serial Digital Input Module 38-804602-xx

▶ The module accepts a serial digital 4:2:2 component video signal (YCbCr) via a single **SERIAL IN** BNC connector. The signal can loop through the **SERIAL OUT** BNC out to another device (such as another projector). Inputs are 75Ω terminated.

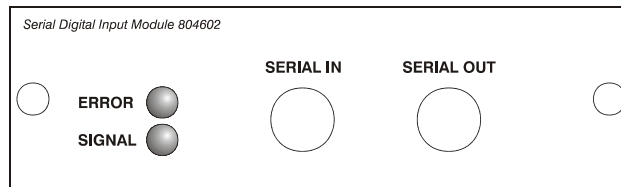

SDI Features

- Accepts serial digital 4:2:2 component video (YCbCr)
- Provides both a **SERIAL IN** and a **SERIAL OUT** BNC connector; includes status LEDs for signal and error
- SMPTE 259M compatible

Dual SD/HD-SDI Module 38-804656-xx

▶ The *Dual SD/HD-SDI Module* enables incoming serial digital (SD or HD) data to be tiled across multiple screen displays, overlapped for extra-bright displays, or distributed to additional projectors for multiple, same-image screens.

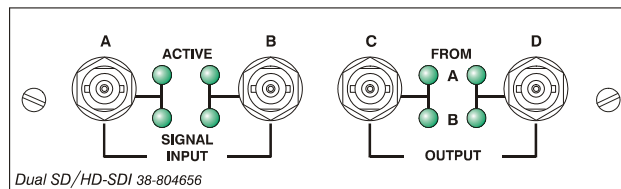

Dual SD/HD-SDI Features

- Accepts and decodes up to two serial digital inputs
- Outputs up to two 10-bit YCbCr 4:2:2 video signals
- Provides input(s) to output(s) loop-through capability
- Supplies interchangeable inputs as part of the Picture-in Picture display
- SMPTE 259M and 372 compatible

Menu Tree

The following menu tree provides a graphical representation of the software menu structure for the Mirage S+/HD/WU, Matrix S+/HD/WU, Christie HD/DS+/DW, DLV. This allows you to quickly locate and navigate to a specific menu, and associated options/secondary menus.

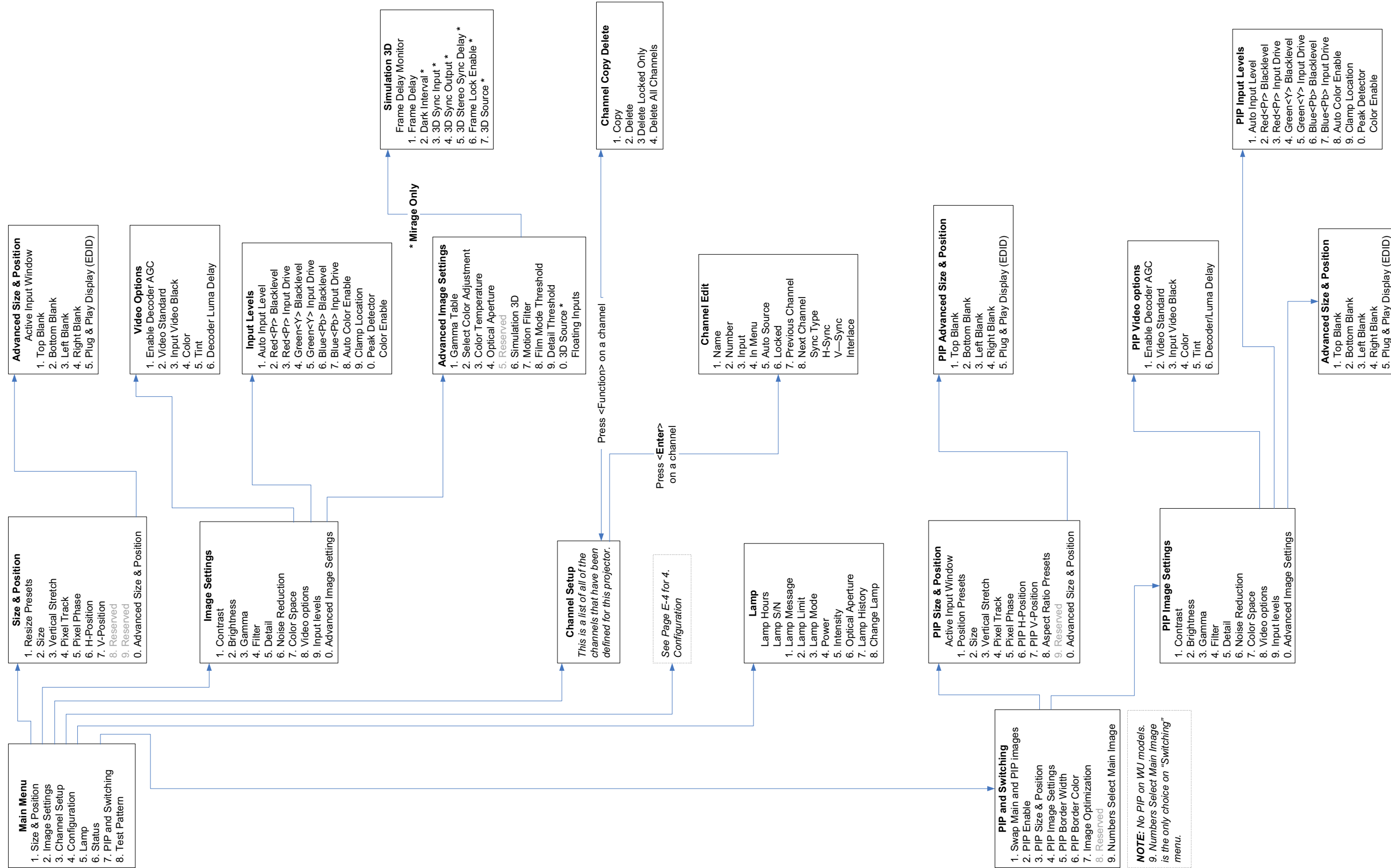

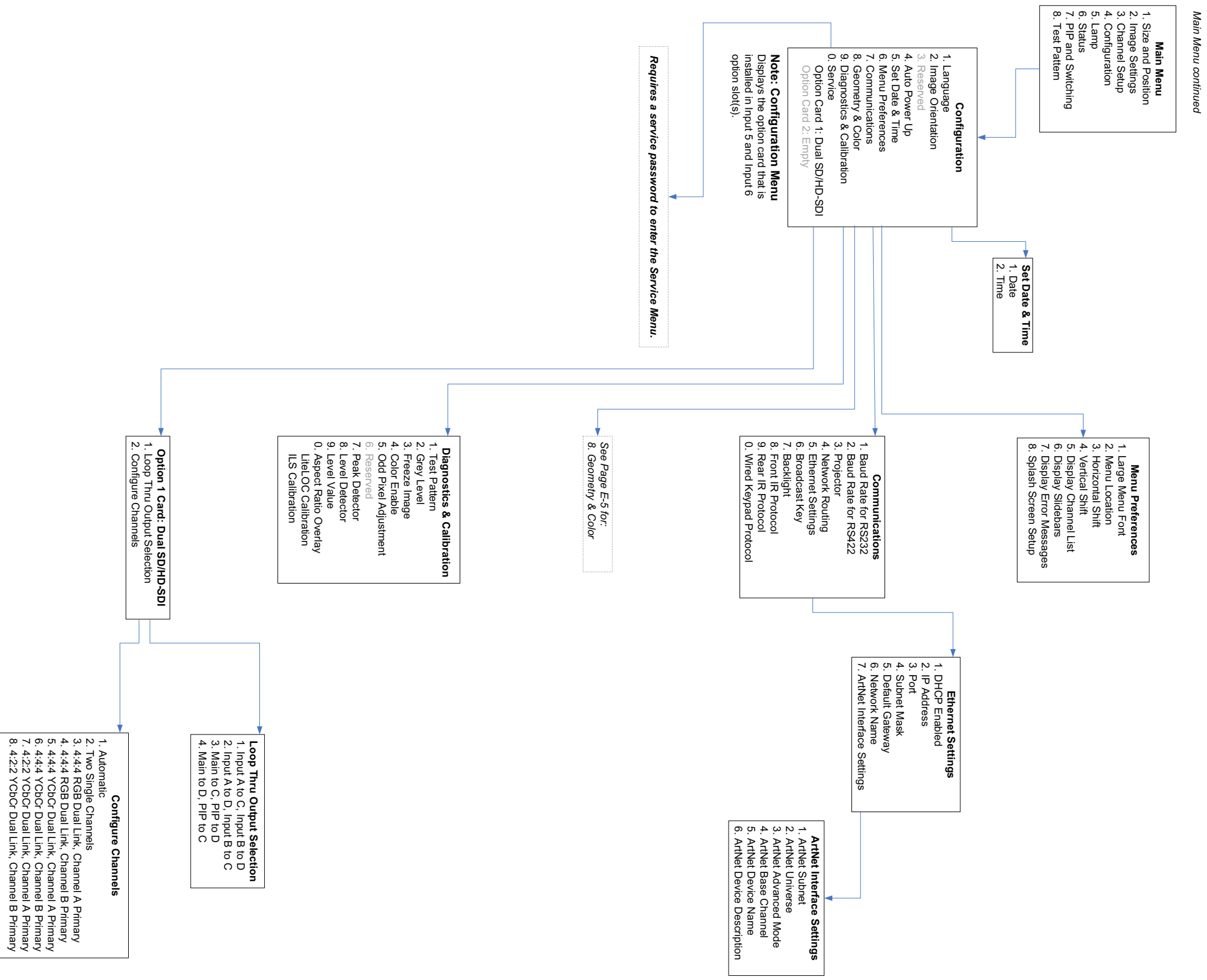



Main Menu continued

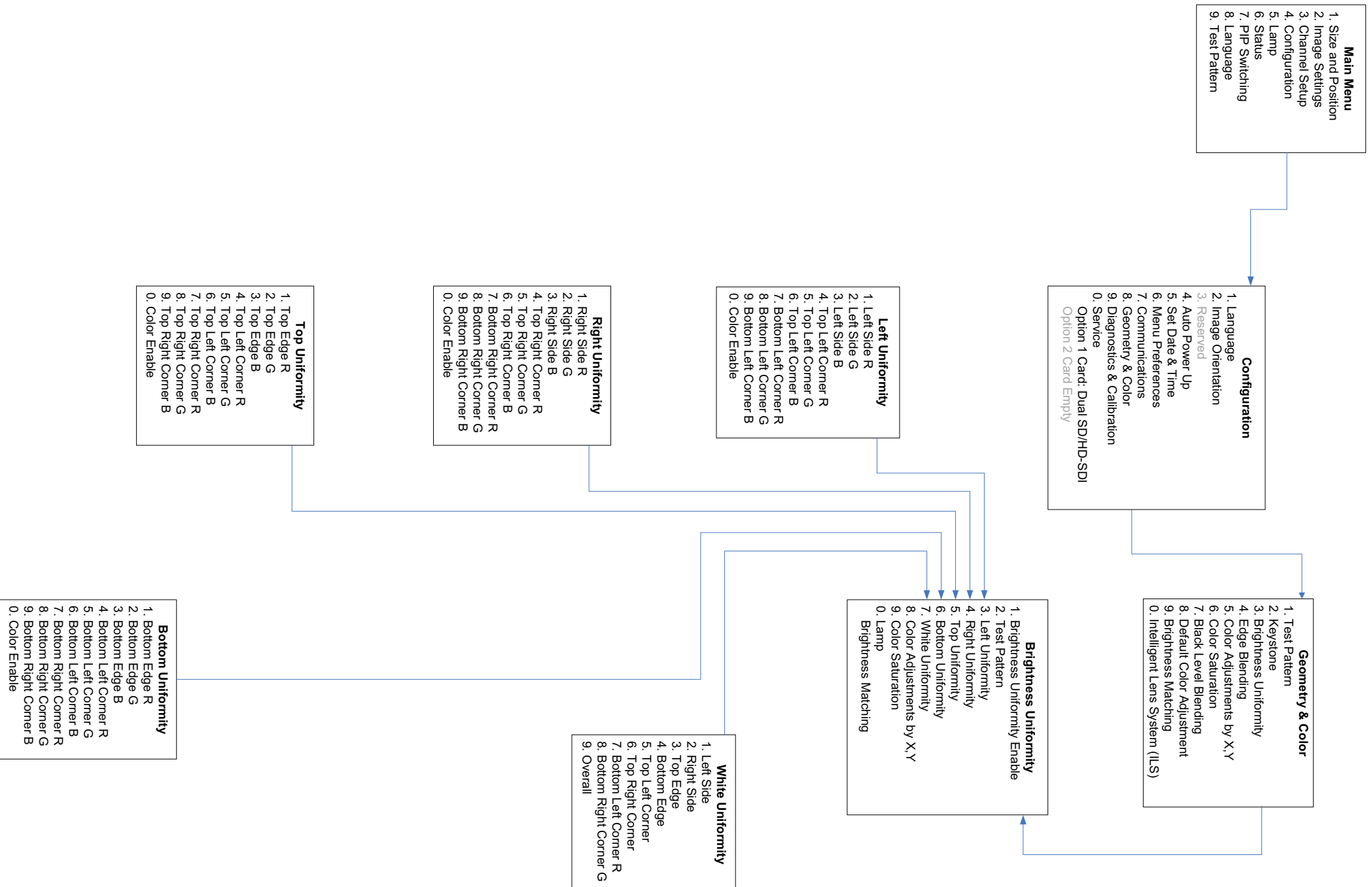

Corporate offices

USA – Cypress
ph: 714-236-8610
Canada – Kitchener
ph: 519-744-8005

Worldwide offices

United Kingdom
ph: +44 118 977 8000
Germany
ph: +49 2161 664540
France
ph: +33 (0) 1 41 21 44 04

Hungary/Eastern Europe
ph: +36 (0) 1 47 48 100
Singapore
ph: +65 6877 8737
Shanghai
ph: +86 21 6278 7708

Beijing
ph: +86 10 6561 0240
Korea
ph: +82 2 702 1601
Japan
ph: +81 3 3599 7481

ISO 9001



ISO 14001



For the most current technical documentation, please visit www.christiedigital.com

CHRISTIE®